

Description

The AZ10A20 PWM servo drive is designed to drive brush-type DC motors at a high switching frequency. To increase system reliability and to reduce cabling costs, the drive is designed for direct integration into your PCB. The AZ10A20 is fully protected against over-voltage, under-voltage, over-current, over-heating and short-circuits. A single digital output indicates operating status. The drive interfaces with digital controllers that have analog $\pm 10V$ output. This servo drive requires only a single unregulated isolated DC power supply, and is fully RoHS (Reduction of Hazardous Substances) compliant.

See Part Numbering Information on last page of datasheet for additional ordering options.

Power Range

Peak Current	10 A
Continuous Current	6 A
Supply Voltage	40 - 175 VDC

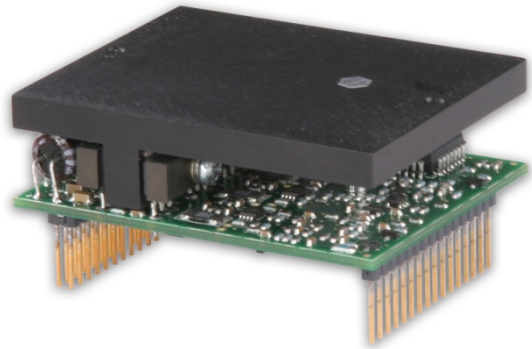

Features

- ▲ High Power Density
- ▲ Compact Size
- ▲ Direct Board-to-Board Integration
- ▲ Lightweight
- ▲ High Switching Frequency
- ▲ Four Quadrant Regenerative Operation
- ▲ Wide Temperature Range
- ▲ High Performance Thermal Dissipation
- ▲ Differential Input Command
- ▲ Current Monitor Output
- ▲ Digital Fault Output Monitor
- ▲ Wide Supply Voltage Range

HARDWARE PROTECTION

- Over-Voltage
- Under-Voltage
- Over-Current
- Over-Temperature
- Short-circuit (phase-phase)
- Short-circuit (phase-ground)

INPUTS/OUTPUTS

- Digital Fault Output
- Digital Inhibit Input
- Analog Current Monitor
- Analog Command Input
- Analog Current Reference

MODES OF OPERATION

- Current

MOTORS SUPPORTED

- Single Phase (Brushed, Voice Coil, Inductive Load)

COMMAND SOURCE

- $\pm 10 V$ Analog



COMPLIANCES & AGENCY APPROVALS

- UL
- cUL
- CE Class A (LVD)
- CE Class A (EMC)
- RoHS

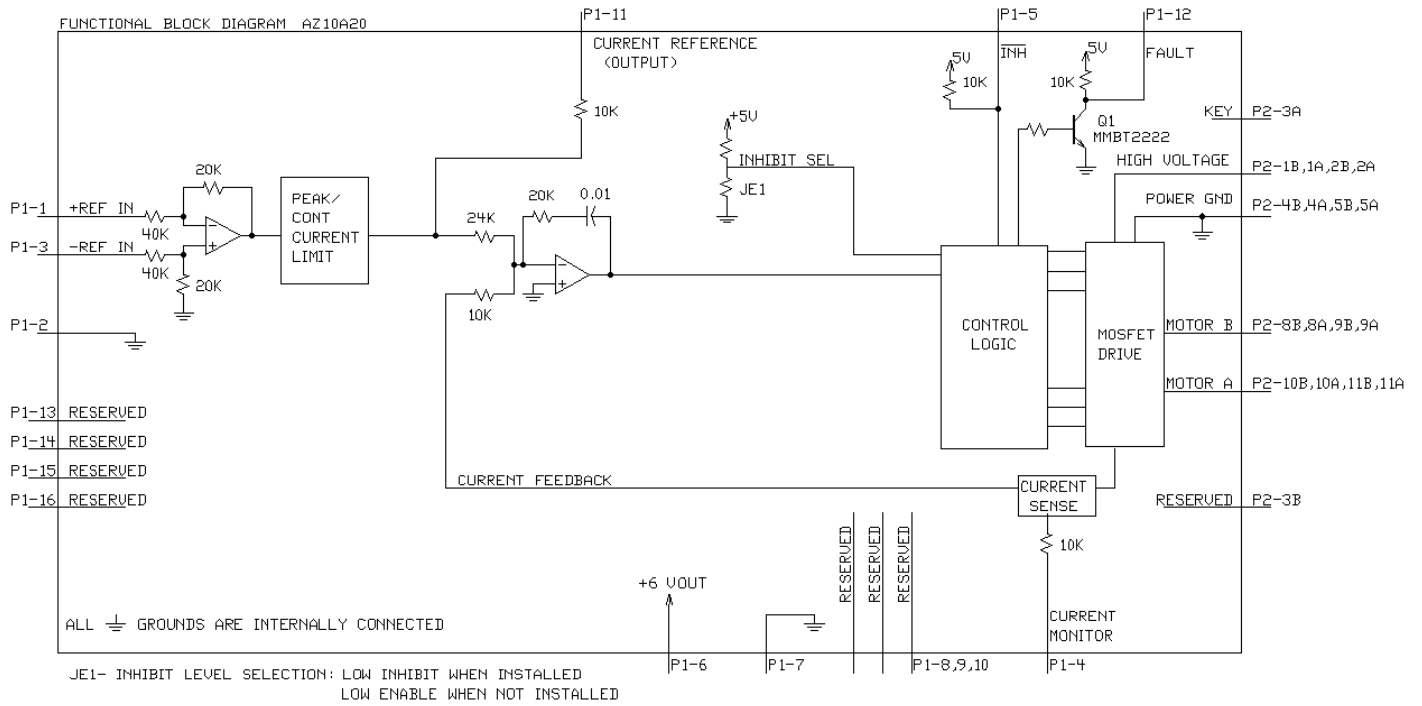
BLOCK DIAGRAM



Information on Approvals and Compliances

	<p>US and Canadian safety compliance with UL 508c, the industrial standard for power conversion electronics. UL registered under file number E140173. Note that machine components compliant with UL are considered UL registered as opposed to UL listed as would be the case for commercial products.</p>
	<p>Compliant with European CE for both the Class A EMC Directive 2004/108/EC on Electromagnetic Compatibility (specifically EN 61000-6-4:2007 and EN 61000-6-2:2005) and LVD requirements of directive 2006/95/EC (specifically EN 60204-1:2006), a low voltage directive to protect users from electrical shock.</p>
	<p>RoHS (Reduction of Hazardous Substances) is intended to prevent hazardous substances such as lead from being manufactured in electrical and electronic equipment.</p>

SPECIFICATIONS

Power Specifications		
Description	Units	Value
DC Supply Voltage Range	VDC	40 - 175
DC Bus Under Voltage Limit	VDC	36
DC Bus Over Voltage Limit	VDC	195
Maximum Peak Output Current ¹	A	10
Maximum Continuous Output Current	A	6
Maximum Continuous Output Power	W	998
Maximum Power Dissipation at Continuous Current	W	53
Minimum Load Inductance (Line-To-Line) ²	μH	250
Internal Bus Capacitance ³	μF	20
Low Voltage Supply Outputs	-	+6 VDC (30 mA)
Switching Frequency	kHz	20.7

Control Specifications		
Description	Units	Value
Command Sources	-	±10 V Analog
Modes of Operation	-	Current
Motors Supported	-	Single Phase (Brushed, Voice Coil, Inductive Load)
Hardware Protection	-	Over Current, Over Temperature, Over Voltage, Under Voltage, Short Circuit (Phase-Phase & Phase-Ground)

Mechanical Specifications		
Description	Units	Value
Agency Approvals	-	CE Class A (EMC), CE Class A (LVD), cUL, RoHS, UL
Size (H x W x D)	mm (in)	63.5 x 50.8 x 22.9 (2.5 x 2 x 0.9)
Weight	g (oz)	94.5 (3.3)
Heatsink (Base) Temperature Range ⁴	°C (°F)	0 - 75 (32 - 167)
Storage Temperature Range	°C (°F)	-40 - 85 (-40 - 185)
P1 Connector	-	16-pin, 2.54 mm spaced header
P2 Connector	-	22-pin, 2.54 mm spaced, dual-row header

Notes

1. Maximum duration of peak current is –2 seconds. Peak RMS value must not exceed continuous current rating of the drive.
2. Lower inductance is acceptable for bus voltages well below maximum. Use external inductance to meet requirements.
3. Requires a 100 μF / 200 V electrolytic capacitor near the P2 Power Connector between High Voltage and Power Ground pins.
4. Additional cooling and/or heatsink may be required to achieve rated performance.

PIN FUNCTIONS

P1 - Signal Connector			
Pin	Name	Description / Notes	I/O
1	+REF IN	Differential Reference Input (± 10 V Operating Range, ± 15 V Maximum Input)	I
2	SIGNAL GND	Signal Ground	GND
3	-REF IN	Differential Reference Input (± 10 V Operating Range, ± 15 V Maximum Input)	I
4	CURRENT MONITOR	Current Monitor. Analog output signal proportional to the actual current output. Scaling is 3.3 A/V. Measure relative to signal ground.	O
5	INHIBIT IN	TTL level (+5 V) inhibit/enable input. Leave open to enable drive. Pull to ground to inhibit drive. Inhibit turns off all power devices.	I
6	+6V 30mA OUT	+6V @ 30mA power supply for customer use.	O
7	SIGNAL GND	Signal Ground	GND
8	RESERVED	Reserved	-
9	RESERVED		-
10	RESERVED		-
11	CURRENT REFERENCE	Measures the command signal to the internal current-loop. This pin has a maximum output of ± 7.4 V when the drive outputs maximum peak current. Measure relative to signal ground.	O
12	FAULT OUT	TTL level (+5 V) output becomes high when power devices are disabled due to at least one of the following conditions: inhibit, output short circuit, over voltage, over temperature, power-up reset.	O
13	RESERVED	Reserved	-
14	RESERVED		-
15	RESERVED		-
16	RESERVED		-

P2 - Power Connector			
Pin	Name	Description / Notes	I/O
1b	1a	DC Power Input. 3A Continuous Current Rating Per Pin. Requires a 100 μ F / 200 V electrolytic capacitor near P2 between High Voltage and Power Ground.	I
2b	2a		I
3b	NC	Not Connected (Reserved) Key: No Connection (pin removed)	-
	3a		-
4b	4a	Power Ground (Common With Signal Ground). 3A Continuous Current Rating Per Pin.	GND
5b	5a		GND
6b	6a	Reserved	-
7b	7a		-
8b	8a		-
9b	9a	Motor Phase Outputs. Current output distributed equally across 4 pins per motor phase, 3A continuous current carrying capacity per pin.	O
10b	10a		O
11b	11a		O

HARDWARE SETTINGS

Jumper Settings

Jumper is a SMT, 0 ohm resistor located on the underside of the drive PCB. By default, the drive is configured with the jumper installed. Typical drive operation will not require the jumper to be removed. Please contact the factory before jumper removal.

Jumper	Description	Configuration	
		Not Installed	Installed
JE1	Inhibit logic. Sets the logic level of inhibit pins. Labeled JE1 on the PCB of the drive.	Low Enable	Low Inhibit

MECHANICAL INFORMATION

P1 - Signal Connector

Connector Information		16-pin, 2.54 mm spaced header
Mating Connector	Details	Samtec: BCS-116-L-S-PE
	Included with Drive	No

P2 - Power Connector

Connector Information		22-pin, 2.54 mm spaced, dual-row header
Mating Connector	Details	Samtec: SSM-111-L-DV
	Included with Drive	No

PART NUMBERING INFORMATION

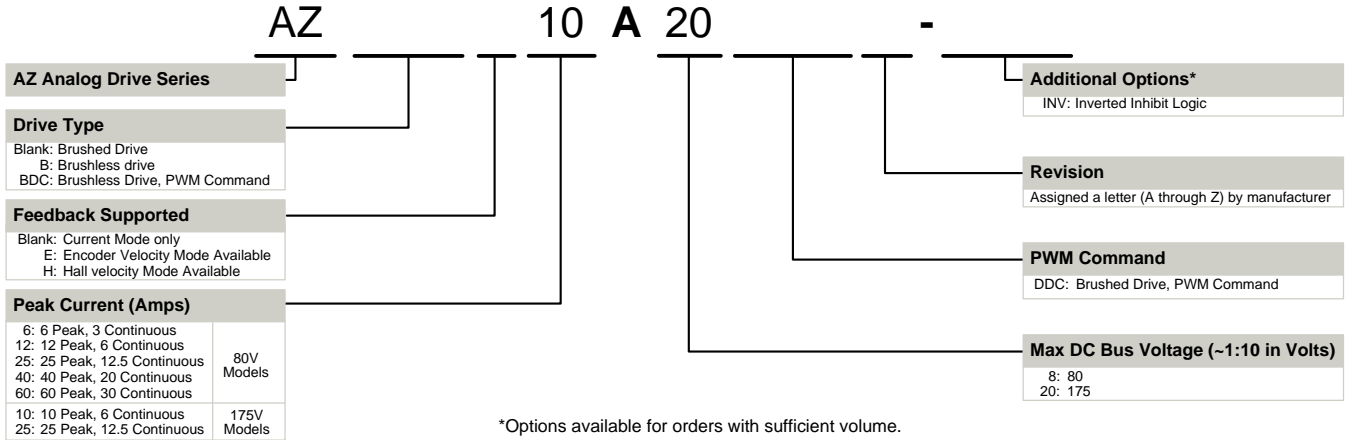

ADVANCED Motion Controls AZ series of servo drives are available in many configurations. Note that not all possible part number combinations are offered as standard drives. All models listed in the selection tables of the website are readily available, standard product offerings.

ADVANCED Motion Controls also has the capability to promptly develop and deliver specified products for OEMs with volume requests. Our Applications and Engineering Departments will work closely with your design team through all stages of development in order to provide the best servo drive solution for your system. Equipped with on-site manufacturing for quick-turn customs capabilities, ADVANCED Motion Controls utilizes our years of engineering and manufacturing expertise to decrease your costs and time-to-market while increasing system quality and reliability.

Examples of Modifications and Customized Products

- ▲ Integration of Drive into Motor Housing
- ▲ Mount OEM PCB onto Drive Without Cables
- ▲ Multi-axis Configuration for Compact System
- ▲ Custom PCB and Baseplate for Optimized Footprint
- ▲ RTV/Epoxy Components for High Vibration
- ▲ OEM Specified Connectors for Instant Compatibility
- ▲ OEM Specified Silkscreen for Custom Appearance
- ▲ Increased Thermal Limits for High Temp. Operation
- ▲ Integrate OEM Circuitry onto Drive PCB
- ▲ Custom Control Loop Tuned to Motor Characteristics
- ▲ Custom I/O Interface for System Compatibility
- ▲ Preset Switches and Pots to Reduce User Setup
- ▲ Optimized Switching Frequency
- ▲ Ramped Velocity Command for Smooth Acceleration
- ▲ Remove Unused Features to Reduce OEM Cost
- ▲ Application Specific Current and Voltage Limits

Feel free to contact Applications Engineering for further information and details.

Available Accessories

ADVANCED Motion Controls offers a variety of accessories designed to facilitate drive integration into a servo system. Visit www.a-m-c.com to see which accessories will assist with your application design and implementation.

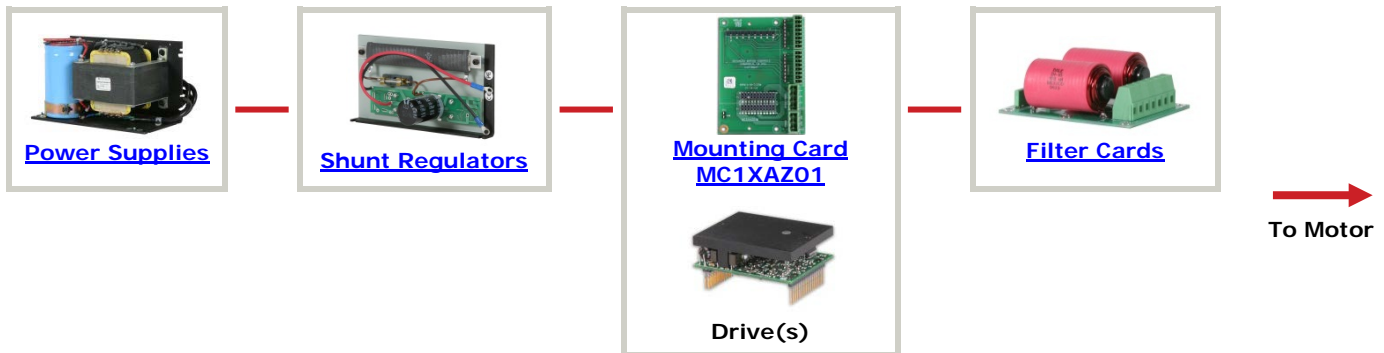

All specifications in this document are subject to change without written notice. Actual product may differ from pictures provided in this document.