

**Description**

The AZXB25A8 PWM servo drive is designed to drive brushless DC motors at a high switching frequency. To increase system reliability and to reduce cabling costs, the drive is designed for direct integration into your PCB. The AZXB30A8 is fully protected against over-voltage, under-voltage, over-current, over-heating and short-circuits. A single digital output indicates operating status. The drive interfaces with digital controllers that have analog  $\pm 10V$  output. This servo drive requires only a single unregulated isolated DC power supply, and is fully RoHS (Reduction of Hazardous Substances) compliant.

The AZXB25A8 conforms to the following specifications and is designed to the Environmental Engineering Considerations as defined in MIL-STD-810F.

Extended Environment Performance	
Ambient Temperature	-40°C to +85°C (-40°F to +185°F)
Storage Temperature	-50°C to +100°C (-58°F to +212°F)
Thermal Shock	-40°C to +85°C (-40°F to +185°F) in 2 min.
Relative Humidity	0 to 95% Non-Condensing
Vibration	30 Grms for 5 min. in 3 axes

**Power Range**

Peak Current	25 A
Continuous Current	12.5 A
Supply Voltage	10 - 80 VDC



See Part Numbering Information on last page of datasheet for additional ordering options.

**Features**

- ▲ High Power Density
- ▲ Compact Size
- ▲ Direct Board-to-Board Integration
- ▲ Lightweight
- ▲ High Switching Frequency
- ▲ Four Quadrant Regenerative Operation
- ▲ Wide Temperature Range
- ▲ High Performance Thermal Dissipation
- ▲ Differential Input Command
- ▲ Current Monitor Output
- ▲ Digital Fault Output Monitor
- ▲ 12VDC Operation

**HARDWARE PROTECTION**

- Over-Voltage
- Under-Voltage
- Over-Current
- Over-Temperature
- Short-circuit (phase-phase)
- Short-circuit (phase-ground)

**INPUTS/OUTPUTS**

- Digital Fault Output
- Digital Inhibit Input
- Analog Current Monitor
- Analog Command Input
- Analog Current Reference

**FEEDBACK SUPPORTED**

- Hall Sensors

**MODES OF OPERATION**

- Current

**COMMUTATION**

- Trapezoidal

**MOTORS SUPPORTED**

- Three Phase (Brushless)
- Single Phase (Brushed, Voice Coil, Inductive Load)

**COMMAND SOURCE**

- $\pm 10$  V Analog



**COMPLIANCES & AGENCY APPROVALS**

- UL
- cUL
- CE Class A (LVD)
- CE Class A (EMC)
- RoHS
- MIL-STD-810F (as stated)
- MIL-STD-1275D (optional)
- MIL-STD-461E (optional)
- MIL-STD-704F (optional)
- MIL-HDBK-217 (optional)

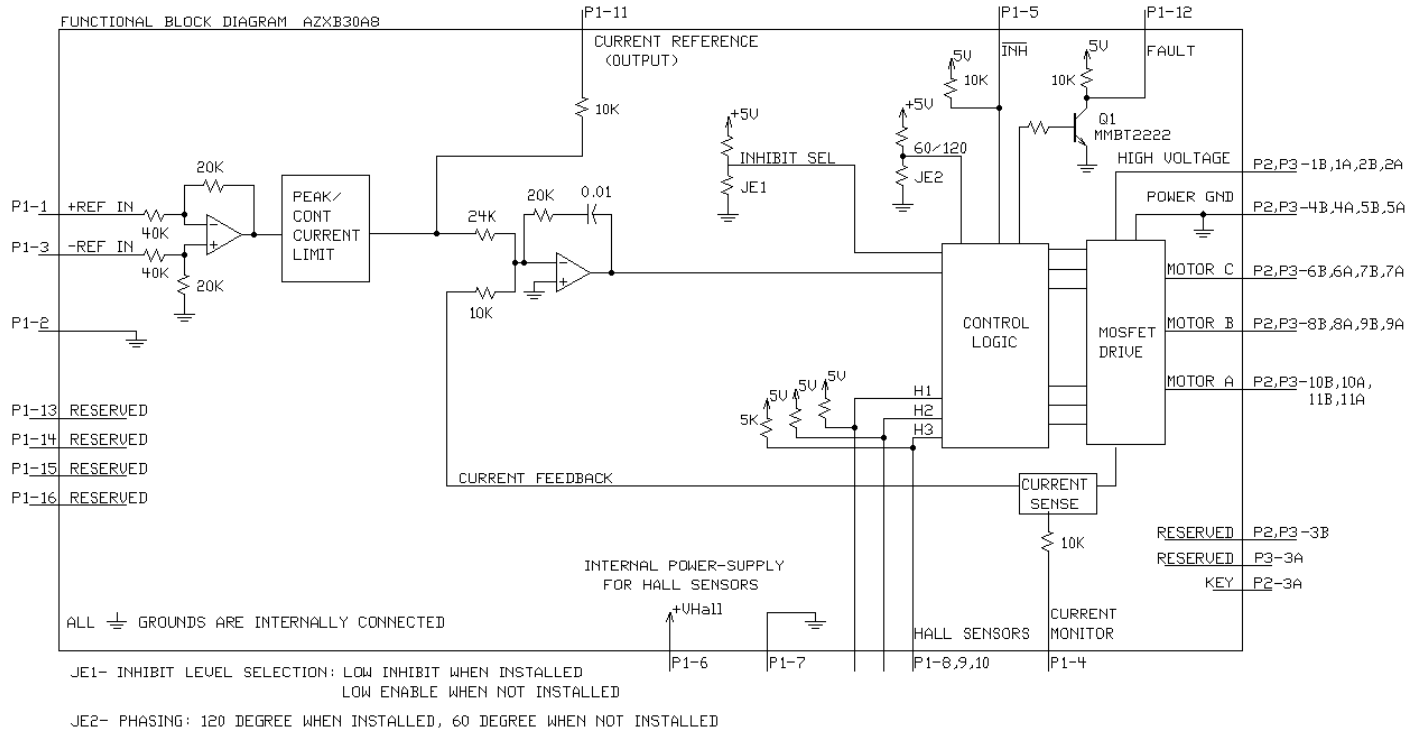
**BLOCK DIAGRAM**



**Information on Approvals and Compliances**

	<p>US and Canadian safety compliance with UL 508c, the industrial standard for power conversion electronics. UL registered under file number E140173. Note that machine components compliant with UL are considered UL registered as opposed to UL listed as would be the case for commercial products.</p>
	<p>Compliant with European CE for both the Class A EMC Directive 2004/108/EC on Electromagnetic Compatibility (specifically EN 61000-6-4:2007 and EN 61000-6-2:2005) and LVD requirements of directive 2006/95/EC (specifically EN 60204-1:2006), a low voltage directive to protect users from electrical shock.</p>
<p>MIL-STD-810F</p>	<p>Environmental Engineering Considerations and Laboratory Tests – (as stated)</p>
<p>MIL-STD-1275D</p>	<p>Characteristics of 28 Volt DC Electrical Systems in Military Vehicles – (optional)</p>
<p>MIL-STD-461E</p>	<p>Requirements for the Control of Electromagnetic Interference Characteristics of Subsystems and Equipment – (optional)</p>
<p>MIL-STD-704F</p>	<p>Aircraft Electric Power Characteristics – (optional)</p>
<p>MIL-HDBK-217</p>	<p>Reliability Prediction of Electronic Equipment (MTBF) – (optional)</p>
	<p>RoHS (Reduction of Hazardous Substances) is intended to prevent hazardous substances such as lead from being manufactured in electrical and electronic equipment. – (optional)</p>

**SPECIFICATIONS**

Power Specifications		
Description	Units	Value
DC Supply Voltage Range	VDC	10 - 80
DC Bus Under Voltage Limit	VDC	9
DC Bus Over Voltage Limit	VDC	88
Maximum Peak Output Current <sup>1</sup>	A	25
Maximum Continuous Output Current	A	12.5
Maximum Continuous Output Power	W	950
Maximum Power Dissipation at Continuous Current	W	50
Minimum Load Inductance (Line-To-Line) <sup>2</sup>	µH	100
Internal Bus Capacitance <sup>3</sup>	µF	30
Low Voltage Supply Outputs	-	+6 VDC (30 mA)
Switching Frequency	kHz	31
Control Specifications		
Description	Units	Value
Command Sources	-	±10 V Analog
Feedback Supported	-	Halls
Commutation Methods	-	Trapezoidal
Modes of Operation	-	Current
Motors Supported	-	Three Phase (Brushless), Single Phase (Brushed, Voice Coil, Inductive Load)
Hardware Protection	-	Invalid Commutation Feedback, Over Current, Over Temperature, Over Voltage, Under Voltage, Short Circuit (Phase-Phase & Phase-Ground)
Mechanical Specifications		
Description	Units	Value
Agency Approvals	-	UL, cUL, CE Class A (EMC), CE Class A (LVD), RoHS, MIL-STD-810F (as stated), MIL-STD-1275D (optional), MIL-STD-461E (optional), MIL-STD-704F (optional), MIL-HDBK-217 (optional)
Size (H x W x D)	mm (in)	76.2 x 50.8 x 22.86 (3 x 2 x 0.9)
Weight	g (oz)	119.7 (4.2)
Baseplate Operating Temperature Range <sup>4</sup>	°C (°F)	-40 - 105 (-40 - 221)
Ambient Temperature Range	°C (°F)	-40 - 85 (-40 - 185)
Storage Temperature Range	°C (°F)	-50 - 100 (-58 - 212)
Thermal Shock	°C (°F)	-40 - 85 (-40 - 185) in 2 minutes
Vibration	Grms	30 for 5 minutes in 3 axes
Relative Humidity	-	0 - 95% Non-Condensing
Form Factor	-	PCB Mounted
P1 Connector	-	16-pin, 2.54 mm spaced header
P2 Connector	-	22-pin, 2.54 mm spaced, dual-row header
P3 Connector	-	22-pin, 2.54 mm spaced, dual-row header

**Notes**

1. Maximum duration of peak current is ~2 seconds. Peak RMS value must not exceed continuous current rating of the drive.
2. Lower inductance is acceptable for bus voltages well below maximum. Use external inductance to meet requirements.
3. It is recommended to connect a 100 µF / 100 V external bus capacitor between High Voltage and Power Ground.
4. Additional cooling and/or heatsink may be required to achieve rated performance.

**PIN FUNCTIONS**

P1 - Signal Connector			
Pin	Name	Description / Notes	I/O
1	+REF IN	Differential Reference Input ( $\pm 10$ V Operating Range, $\pm 15$ V Maximum Input)	I
2	SIGNAL GND	Signal Ground	GND
3	-REF IN	Differential Reference Input ( $\pm 10$ V Operating Range, $\pm 15$ V Maximum Input)	I
4	CURRENT MONITOR	Current Monitor. Analog output signal proportional to the actual current output. Scaling is 13.5 A/V. Measure relative to signal ground.	O
5	INHIBIT IN	TTL level (+5 V) inhibit/enable input. Leave open to enable drive. Pull to ground to inhibit drive. Inhibit turns off all power devices.	I
6	+V HALL OUT	Low Power Supply For Hall Sensors (+6 V @ 30 mA). Referenced to signal ground. Short circuit protected.	O
7	SIGNAL GND	Signal Ground	GND
8	HALL 1	Single-ended Hall/Commutation Sensor Inputs (+5 V logic level)	I
9	HALL 2*		I
10	HALL 3		I
11	CURRENT REFERENCE	Measures the command signal to the internal current-loop. This pin has a maximum output of $\pm 7.3$ V when the drive outputs maximum peak current. Measure relative to signal ground.	O
12	FAULT OUT	TTL level (+5 V) output becomes high when power devices are disabled due to at least one of the following conditions: inhibit, invalid Hall state, output short circuit, over voltage, over temperature, power-up reset.	O
13	RESERVED	Reserved	-
14	RESERVED		-
15	RESERVED		-
16	RESERVED		-

P2 and P3 - Power Connector			
Pin	Name	Description / Notes	I/O
1b	1a	DC Power Input. 3A Continuous Current Rating Per Pin. It is recommended to connect a 100 $\mu$ F / 100 V external capacitor between High Voltage and Power Ground.	I
2b	2a		I
3b	NC	Not Connected (Reserved)	-
	3a	Key: No Connection (pin removed) for P2. Not Connected (Reserved) for P3.	-
4b	4a	Power Ground (Common With Signal Ground). 3A Continuous Current Rating Per Pin.	GND
5b	5a		GND
6b	6a	Motor Phase Outputs. Current output distributed equally across both P2 and P3 connectors – 8 pins per motor phase, 3A continuous current carrying capacity per pin.	O
7b	7a		O
8b	8a		O
9b	9a		O
10b	10a		O
11b	11a		O

\*For use with Single Phase (Brushed) motors, ground Hall 2 and only connect motor leads to Motor A and Motor B.

**HARDWARE SETTINGS**

**Jumper Settings**

The drive PCB is conformal coated, thereby making it difficult to change jumper settings. Jumpers are SMT 0 ohm resistors located on the underside of the drive PCB. By default, the drive is configured with the jumpers installed. Typical drive operation will not require the jumpers to be removed. Please contact the factory before jumper removal.

Jumper	Description	Configuration	
		Not Installed	Installed
JE1	Inhibit logic. Sets the logic level of inhibit pins. Labeled JE1 on the PCB of the drive.	Low Enable	Low Inhibit
JE2	Hall sensor phasing. Selects 120 or 60 degree commutation phasing. Labeled JE2 on the PCB of the drive.	60 degree	120 degree

**MECHANICAL INFORMATION**

**P1 - Signal Connector**

Connector Information		16-pin, 2.54 mm spaced header
Mating Connector	Details	Samtec: BCS-116-L-S-PE
	Included with Drive	No

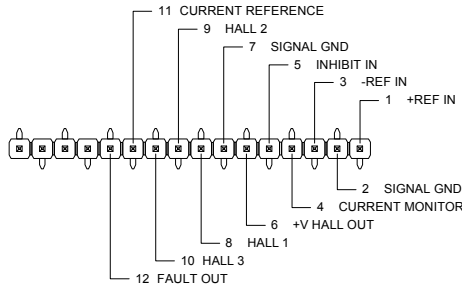

**P2 - Power Connector**

Connector Information		22-pin, 2.54 mm spaced, dual-row header
Mating Connector	Details	Samtec: SSM-111-L-DV
	Included with Drive	No

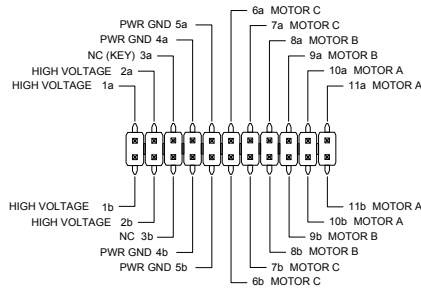

**P3 - Power Connector**

Connector Information		22-pin, 2.54 mm spaced, dual-row header
Mating Connector	Details	Samtec: SSM-111-L-DV
	Included with Drive	No

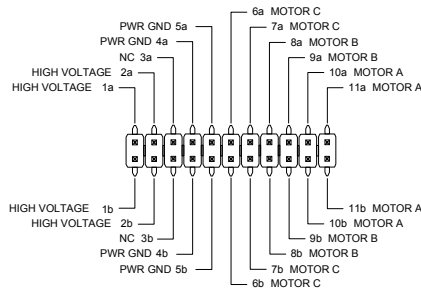

**MOUNTING DIMENSIONS**

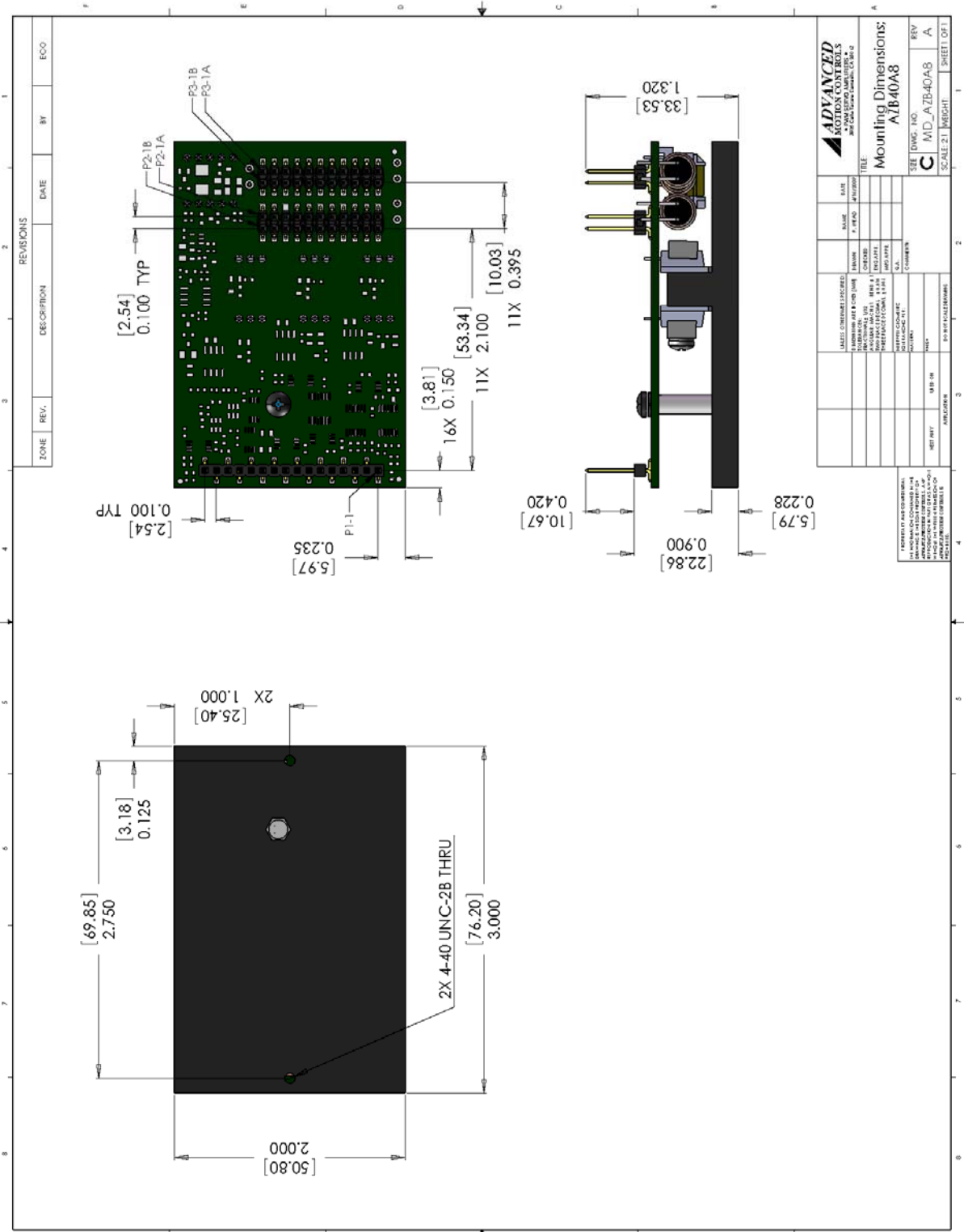

**PART NUMBERING INFORMATION**

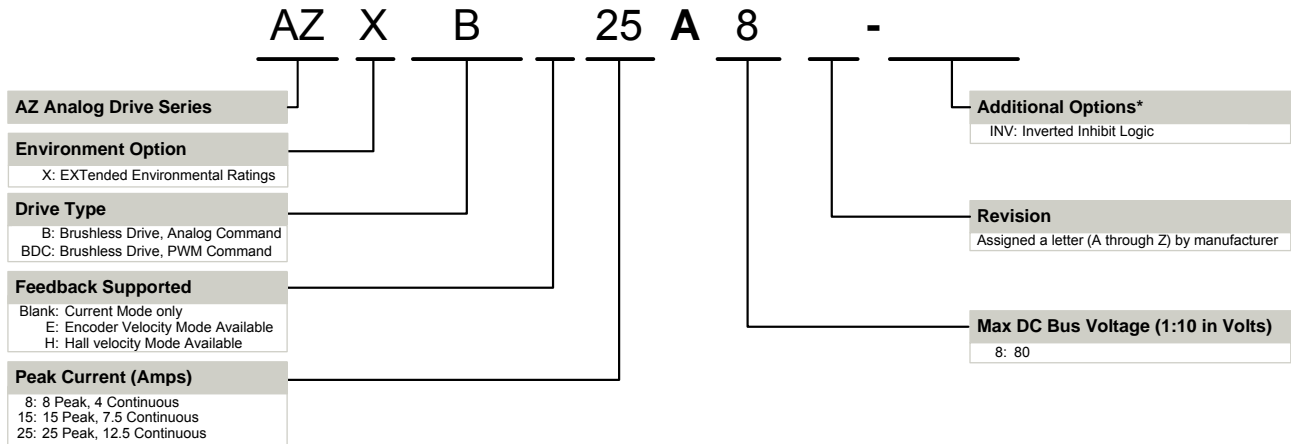

\*Options available for orders with sufficient volume. Contact *ADVANCED* Motion Controls for more information.

*ADVANCED* Motion Controls AZ series of servo drives are available in many configurations. Note that not all possible part number combinations are offered as standard drives. All models listed in the selection tables of the website are readily available, standard product offerings.

*ADVANCED* Motion Controls also has the capability to promptly develop and deliver specified products for OEMs with volume requests. Our Applications and Engineering Departments will work closely with your design team through all stages of development in order to provide the best servo drive solution for your system. Equipped with on-site manufacturing for quick-turn customs capabilities, *ADVANCED* Motion Controls utilizes our years of engineering and manufacturing expertise to decrease your costs and time-to-market while increasing system quality and reliability.

**Examples of Modifications and Customized Products**

- ▲ Integration of Drive into Motor Housing
- ▲ Mount OEM PCB onto Drive Without Cables
- ▲ Multi-axis Configuration for Compact System
- ▲ Custom PCB and Baseplate for Optimized Footprint
- ▲ RTV/Epoxy Components for High Vibration
- ▲ OEM Specified Connectors for Instant Compatibility
- ▲ OEM Specified Silkscreen for Custom Appearance
- ▲ Increased Thermal Limits for High Temp. Operation
- ▲ Integrate OEM Circuitry onto Drive PCB
- ▲ Custom Control Loop Tuned to Motor Characteristics
- ▲ Custom I/O Interface for System Compatibility
- ▲ Preset Switches and Pots to Reduce User Setup
- ▲ Optimized Switching Frequency
- ▲ Ramped Velocity Command for Smooth Acceleration
- ▲ Remove Unused Features to Reduce OEM Cost
- ▲ Application Specific Current and Voltage Limits

Feel free to contact Applications Engineering for further information and details.

**Available Accessories**

*ADVANCED* Motion Controls offers a variety of accessories designed to facilitate drive integration into a servo system. Visit [www.a-m-c.com](http://www.a-m-c.com) to see which accessories will assist with your application design and implementation.

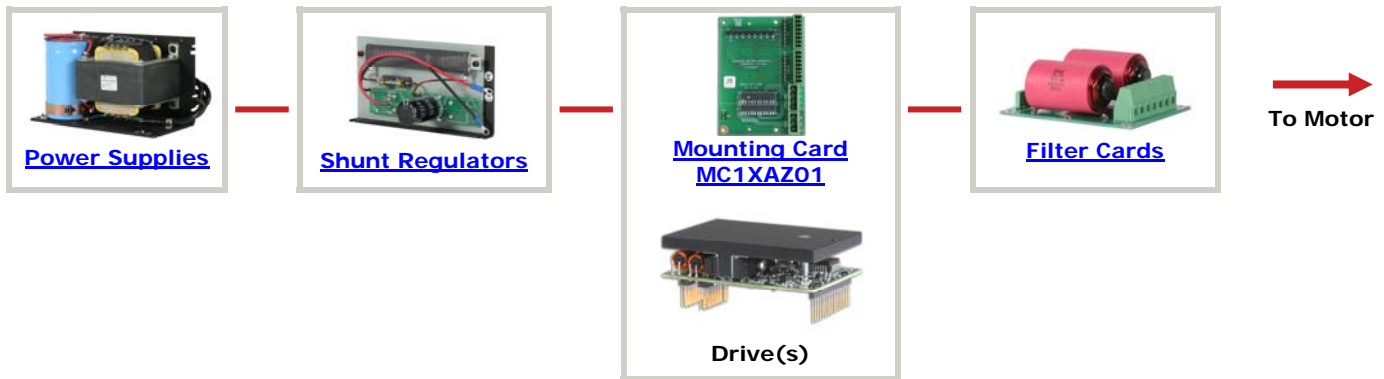

All specifications in this document are subject to change without written notice. Actual product may differ from pictures provided in this document.