

Description

The B25A20I PWM servo drive is designed to drive brushless DC motors at a high switching frequency. A single red/green LED indicates operating status. The drive is fully protected against over-voltage, under voltage, over-current, over-heating and short-circuits across motor, ground and power leads. Furthermore, the drive can interface with digital controllers or be used stand-alone, and requires only a single unregulated DC power supply. Loop gain, current limit, input gain and offset can be adjusted using 14-turn potentiometers. The offset adjusting potentiometer can also be used as an on-board input signal for testing purposes.

See Part Numbering Information on last page of datasheet for additional ordering options.

Power Range

Peak Current	25 A
Continuous Current	12.5 A
Supply Voltage	40 - 190 VDC



Features

- ▲ Optical Isolation Between High & Low Power Signals
- ▲ Four Quadrant Regenerative Operation
- ▲ DIP Switch Selectable Modes
- ▲ Adjustable Current Limits
- ▲ Differential Input Command
- ▲ On-Board Test Potentiometer
- ▲ Offset Adjustment Potentiometer
- ▲ Adjustable Input Gain
- ▲ Selectable 120/60 Hall Commutation Phasing
- ▲ Hall Velocity Mode
- ▲ Drive Status LED
- ▲ Velocity Monitor Outputs

MODES OF OPERATION

- Current
- Duty Cycle (Open Loop)
- Hall Velocity
- Velocity

COMMAND SOURCE

- ±10 V Analog

FEEDBACK SUPPORTED

- Halls
- Tachometer (±60 VDC)



COMPLIANCES & AGENCY APPROVALS

- UL
- cUL
- CE Class A (LVD)
- CE Class A (EMC)
- RoHS

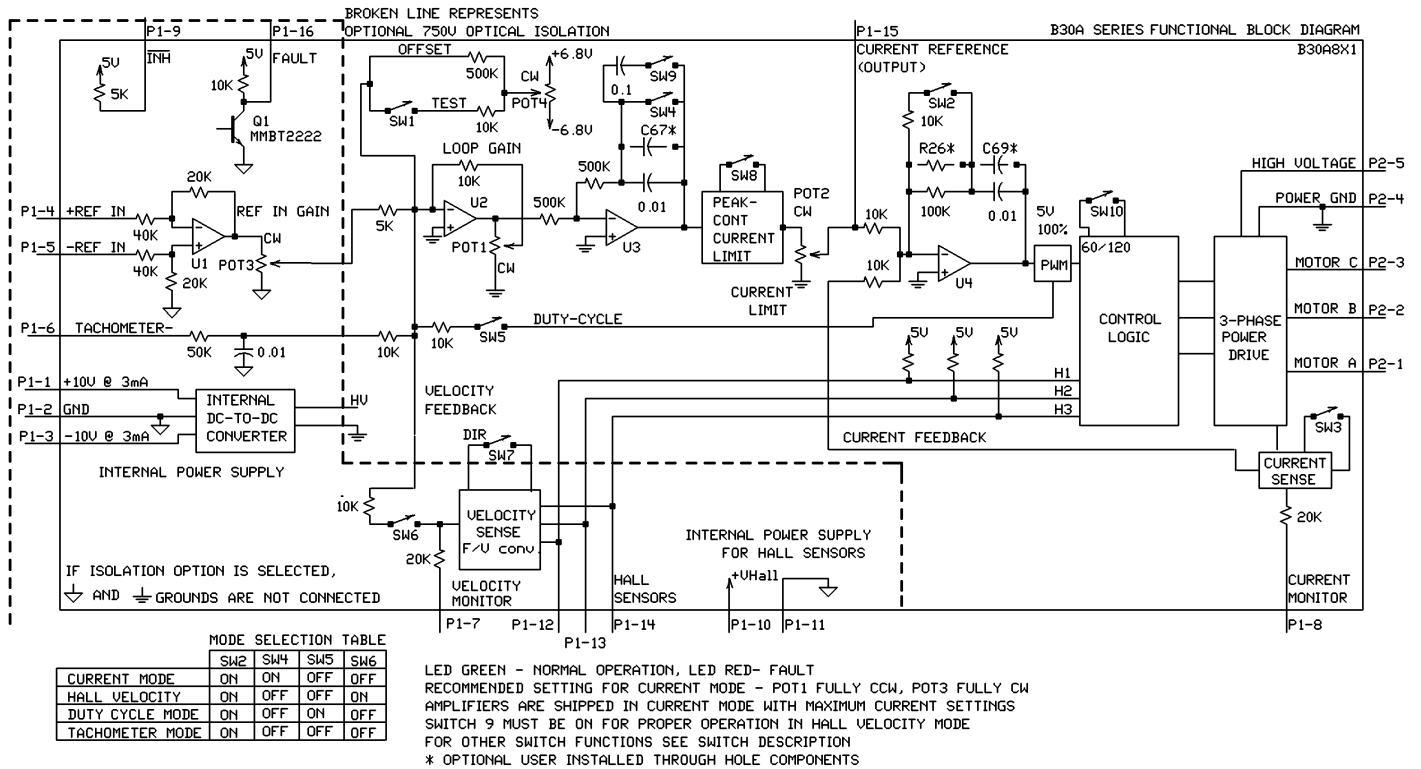
BLOCK DIAGRAM



Information on Approvals and Compliances

	<p>US and Canadian safety compliance with UL 508c, the industrial standard for power conversion electronics. UL registered under file number E140173. Note that machine components compliant with UL are considered UL registered as opposed to UL listed as would be the case for commercial products.</p>
	<p>Compliant with European CE for both the Class A EMC Directive 2004/108/EC on Electromagnetic Compatibility (specifically EN 61000-6-4:2007 and EN 61000-6-2:2005) and LVD requirements of directive 2006/95/EC (specifically EN 60204-1:2006), a low voltage directive to protect users from electrical shock.</p>
	<p>RoHS (Reduction of Hazardous Substances) is intended to prevent hazardous substances such as lead from being manufactured in electrical and electronic equipment.</p>

SPECIFICATIONS

Power Specifications		
Description	Units	Value
DC Supply Voltage Range	VDC	40 - 190
DC Bus Over Voltage Limit	VDC	195
Maximum Peak Output Current ¹	A	25
Maximum Continuous Output Current	A	12.5
Maximum Continuous Output Power	W	2256
Maximum Power Dissipation at Continuous Current	W	119
Minimum Load Inductance (Line-To-Line) ²	µH	250
Low Voltage Supply Outputs	-	±10 VDC (3 mA), +6 VDC (30 mA)
Switching Frequency	kHz	22
Control Specifications		
Description	Units	Value
Command Sources	-	±10 V Analog
Feedback Supported	-	Halls, Tachometer (±60 VDC)
Commutation Methods	-	Trapezoidal
Modes of Operation	-	Current, Hall Velocity, Duty Cycle, Velocity
Motors Supported	-	Single Phase (Brushed, Voice Coil, Inductive Load), Three Phase (Brushless)
Hardware Protection	-	Invalid Commutation Feedback, Over Current, Over Temperature, Over Voltage, Short Circuit (Phase-Phase & Phase-Ground)
Primary I/O Logic Level	-	5V TTL
Mechanical Specifications		
Description	Units	Value
Agency Approvals	-	CE Class A (EMC), CE Class A (LVD), cUL, RoHS, UL
Size (H x W x D)	mm (in)	186.7 x 111.7 x 25.4 (7.4 x 4.4 x 1)
Weight	g (oz)	680 (24)
Heatsink (Base) Temperature Range ³	°C (°F)	0 - 65 (32 - 149)
Storage Temperature Range	°C (°F)	-40 - 85 (-40 - 185)
Form Factor	-	Panel Mount
P1 Connector	-	16-pin, 2.54 mm spaced, friction lock header
P2 Connector	-	5-port, 5.08 mm spaced, screw terminal

Notes

1. Maximum duration of peak current is ~2 seconds. Peak RMS value must not exceed continuous current rating of the drive.
2. Lower inductance is acceptable for bus voltages well below maximum. Use external inductance to meet requirements.
3. Additional cooling and/or heatsink may be required to achieve rated performance.

PIN FUNCTIONS

P1 - Signal Connector			
Pin	Name	Description / Notes	I/O
1	+10V 3mA OUT	±10 V @ 3 mA low power supply for customer use. Short circuit protected. Reference ground common with signal ground.	O
2	SIGNAL GND		SGND
3	-10V 3mA OUT		O
4	+REF IN	Differential Reference Input (±10 V Operating Range, ±15 V Maximum Input)	I
5	-REF IN		I
6	-TACH IN		I
7	VEL MONITOR OUT	Velocity Monitor. Analog output proportional to motor speed. In Hall Velocity mode, output is proportional to the electrical cycle frequency. Hall Velocity scaling is 125 Hz/V.	O
8	CURR MONITOR OUT	Current Monitor. Analog output signal proportional to the actual current output. Scaling is 4.1 A/V by default but may be reduced by half this value by setting DIP switch SW-3 to OFF (see Hardware Settings section below). Measure relative to power ground.	O
9	INHIBIT IN	TTL level (+5 V) inhibit/enable input. Leave open to enable drive. Pull to ground to inhibit drive. Inhibit turns off all power devices.	I
10	+V HALL 30mA OUT	Low Power Supply For Hall Sensors (+6 V @ 30 mA). Referenced to signal ground. Short circuit protected.	O
11	GND	Signal Ground	SGND
12	HALL 1	Single-ended Hall/Commutation Sensor Inputs (+5 V logic level)	I
13	HALL 2		I
14	HALL 3		I
15	CURRENT REF OUT	Measures the command signal to the internal current-loop. This pin has a maximum output of ±7.25 V when the drive outputs maximum peak current. Measure relative to power ground.	O
16	FAULT OUT	TTL level (+5 V) output becomes high when power devices are disabled due to at least one of the following conditions: inhibit, invalid Hall state, output short circuit, over voltage, over temperature, power-up reset.	O

P2 - Power Connector			
Pin	Name	Description / Notes	I/O
1	MOTOR A	Motor Phase A	O
2	MOTOR B	Motor Phase B	O
3	MOTOR C	Motor Phase C	O
4	PWR GND	Power Ground (Isolated From Signal Ground)	PGND
5	HIGH VOLTAGE	DC Power Input	I

HARDWARE SETTINGS

Switch Functions

Switch	Description	Setting	
		On	Off
1	Test/Offset. Switches the function of the Test/Offset pot between an on-board command input for testing or a command offset adjustment. OFF by default.	Test	Offset
2	Current loop proportional gain adjustment. ON by default.	Decrease	Increase
3	Current scaling. When OFF, increases sensitivity of current sense thus reducing both peak and continuous current limit by 50%. The scaling of the current monitor output signal becomes ½ its ordinary value when this switch is OFF.	Full-current	Half-current
4	Outer loop integration. Activates or deactivates integration. ON, by default, for current mode and OFF for other modes.	Inactive	Active
5	Mode selection. See mode selection table below.	-	-
6	Mode selection. See mode selection table below.	-	-
7	Velocity feedback polarity. Changes the polarity of the internal feedback signal and the velocity monitor output signal. Inversion of the feedback polarity may be required to prevent a motor run-away condition.	Standard	Inverted
8	Current ratio. Used to set continuous-to-peak current ratio. Default is ON.	Cont./Peak Ratio = 50%	Cont./Peak Ratio = 25%
9	Outer loop integral gain adjustment. It is recommended to leave this switch OFF for most applications, but ON for Hall Velocity Mode.	Decrease	Increase
10	Hall sensor phasing. Selects 120°/60° commutation phasing. ON by default.	120°	60°

Mode Selection Table

	SW2	SW4	SW5	SW6	Tachometer
CURRENT	ON	ON	OFF	OFF	Not Connected
DUTY CYCLE	ON	OFF	ON	OFF	Not Connected
HALL VELOCITY*	ON	OFF	OFF	ON	Not Connected
TACHOMETER VELOCITY	ON	OFF	OFF	OFF	Connected

*NOTE: See details of switch 7 and 9 for further Hall Velocity configuration information.

Potentiometer Functions

Potentiometer	Description	Turning CW
1	Loop gain adjustment for duty cycle / velocity modes. Turn this pot fully CCW in current mode.	Increases gain
2	Current limit. It adjusts both continuous and peak current limit while maintaining their ratio.	Increases limit
3	Reference gain. Adjusts the ratio between input signal and output variables (voltage, current, or velocity).	Increases gain
4	Offset / Test. Used to adjust any imbalance in the input signal or in the amplifier. Can also be used as an on-board signal source for testing purposes.	Adjusts offset in negative direction

Note: Potentiometers are approximately linear and have 12 active turns with 1 inactive turn on each end.

Through-hole Components[†]

Location	Description
C67*	Velocity Loop Integrator. Through-hole capacitor that can be added for more precise velocity loop tuning. See section below on Tuning with Through-hole components for more details.
C69*	Current Loop Integrator. Through-hole capacitor that can be added for more precise current loop tuning. See section below on Tuning with Through-hole components for more details.
R26*	Current Loop Proportional Gain. Through-hole resistor that can be added for more precise current loop tuning. See section below on Tuning with Through-hole components for more details.

Tuning With Through-hole Components

In general, the drive will not need to be further tuned with through-hole components. However, for applications requiring more precise tuning than what is offered by the potentiometers and dials, the drive can be manually modified with through-hole resistors and capacitors as denoted in the above table. By default, the through-hole locations are not populated when the drive is shipped. Before attempting to add through-hole components to the board, consult the section on loop tuning in the installation notes on the manufacturer's website. Some general rules of thumb to follow when adding through-hole components are:

- A larger resistor value will increase the proportional gain, and therefore create a faster response time.
- A larger capacitor value will increase the integration time, and therefore create a slower response time.

Proper tuning using the through-hole components will require careful observation of the loop response on a digital oscilloscope to find the optimal through-hole component values for the specific application.

[†]Note: Damage done to the drive while performing these modifications will void the warranty.

MECHANICAL INFORMATION

P1 - Signal Connector

Connector Information		16-pin, 2.54 mm spaced, friction lock header
Mating Connector	Details	Molex: P/N 22-01-3167 (connector) and P/N 08-50-0114 (insert terminals)
	Included with Drive	Yes

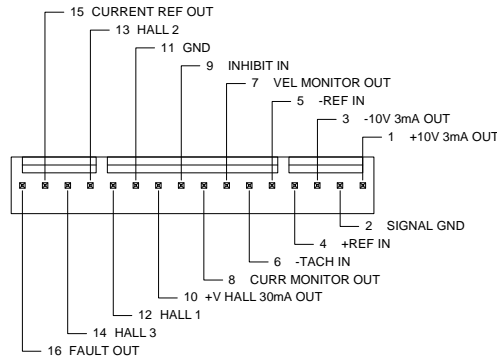

P2 - Power Connector

Connector Information		5-port, 5.08 mm spaced, screw terminal
Mating Connector	Details	Not applicable
	Included with Drive	Not applicable

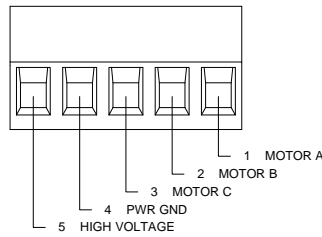

MOUNTING DIMENSIONS

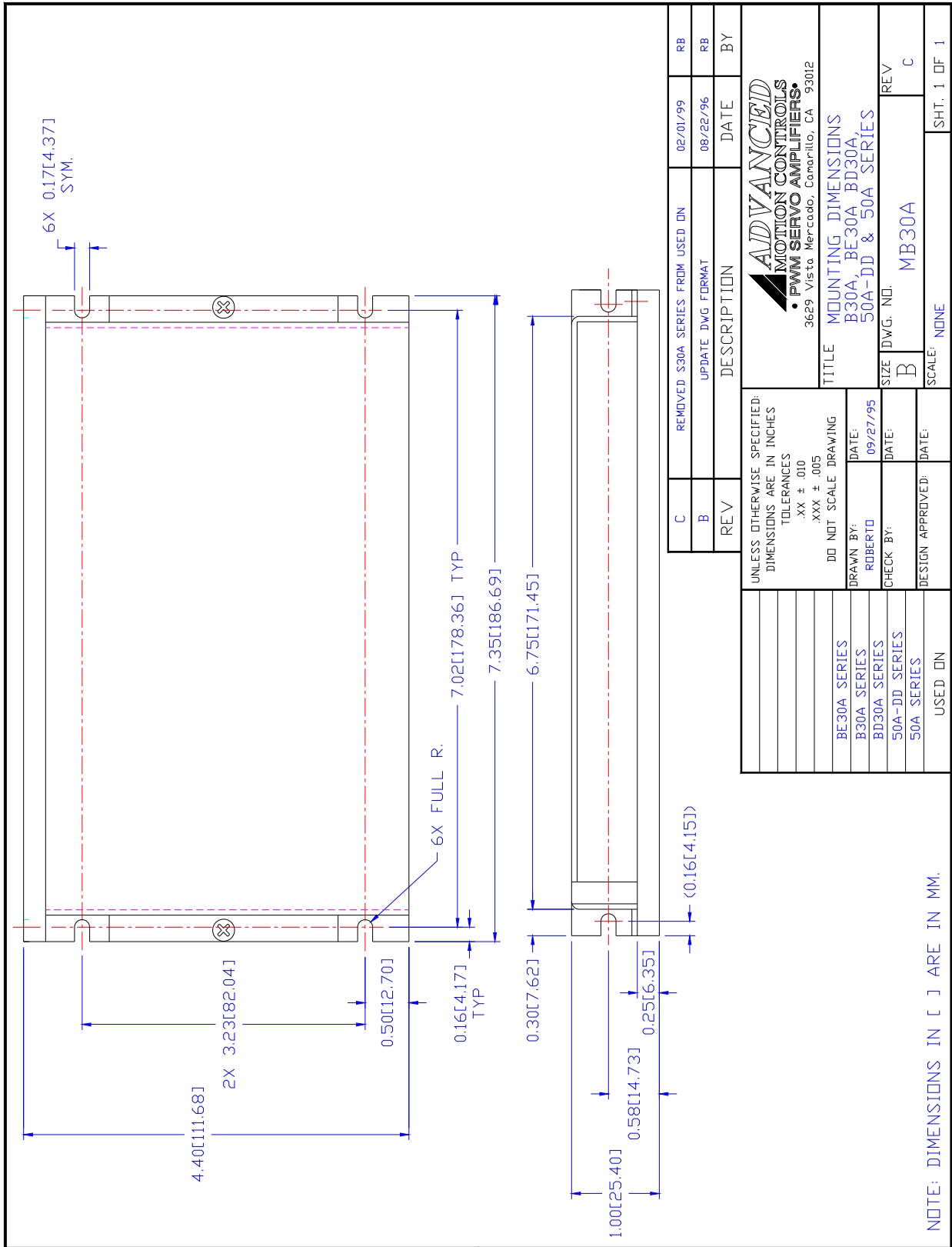

PART NUMBERING INFORMATION

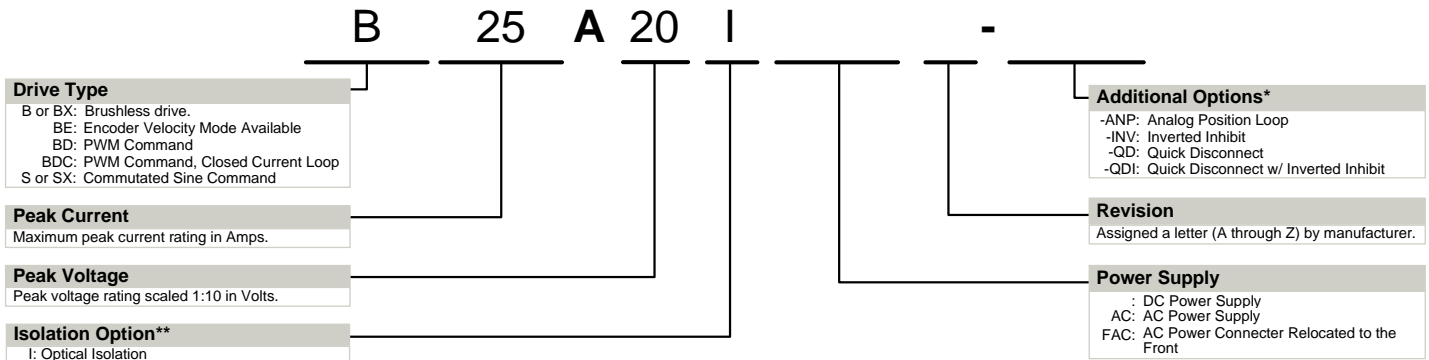

* Options available for orders with sufficient volume. Contact *ADVANCED* Motion Controls for more information.
 ** Isolation comes standard on all AC supply drives and most DC supply drives 200V and above. Consult selection tables of the website or the drive datasheet block diagram to see if isolation is included.

ADVANCED Motion Controls analog series of servo drives are available in many configurations. Note that not all possible part number combinations are offered as standard drives. All models listed in the selection tables of the website are readily available, standard product offerings.

ADVANCED Motion Controls also has the capability to promptly develop and deliver specified products for OEMs with volume requests. Our Applications and Engineering Departments will work closely with your design team through all stages of development in order to provide the best servo drive solution for your system. Equipped with on-site manufacturing for quick-turn customs capabilities, *ADVANCED* Motion Controls utilizes our years of engineering and manufacturing expertise to decrease your costs and time-to-market while increasing system quality and reliability.

- | Examples of Modifications and Customized Products | |
|---|--|
| <ul style="list-style-type: none"> ▲ Integration of Drive into Motor Housing ▲ Mount OEM PCB onto Drive Without Cables ▲ Multi-axis Configuration for Compact System ▲ Custom PCB and Baseplate for Optimized Footprint ▲ RTV/Epoxy Components for High Vibration ▲ OEM Specified Connectors for Instant Compatibility ▲ OEM Specified Silkscreen for Custom Appearance ▲ Increased Thermal Limits for High Temp. Operation | <ul style="list-style-type: none"> ▲ Integrate OEM Circuitry onto Drive PCB ▲ Custom Control Loop Tuned to Motor Characteristics ▲ Custom I/O Interface for System Compatibility ▲ Preset Switches and Pots to Reduce User Setup ▲ Optimized Switching Frequency ▲ Ramped Velocity Command for Smooth Acceleration ▲ Remove Unused Features to Reduce OEM Cost ▲ Application Specific Current and Voltage Limits |

Feel free to contact Applications Engineering for further information and details.

Available Accessories

ADVANCED Motion Controls offers a variety of accessories designed to facilitate drive integration into a servo system. Visit www.a-m-c.com to see which accessories will assist with your application design and implementation.

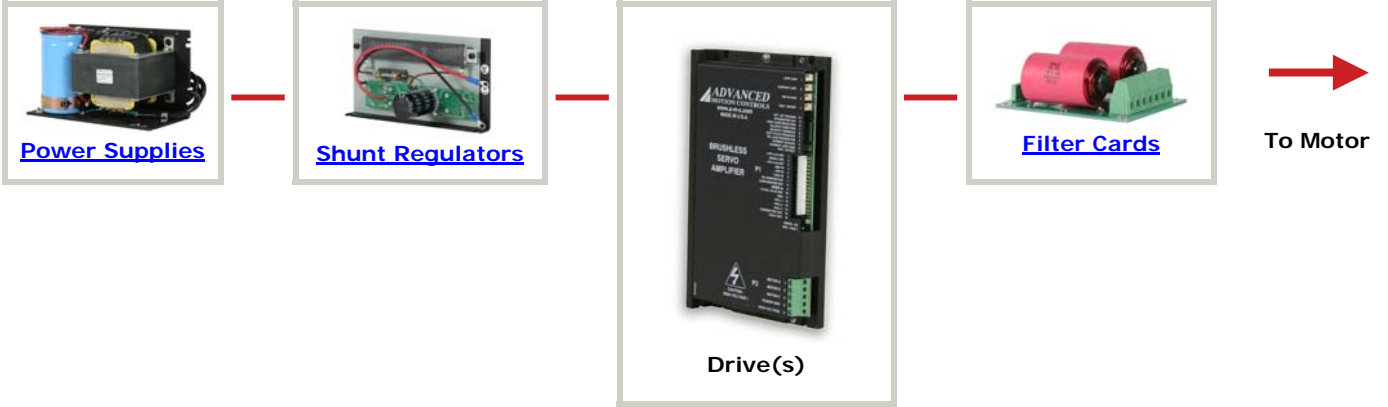

All specifications in this document are subject to change without written notice. Actual product may differ from pictures provided in this document.