

Description

The MC1XDZPE01 mounting card is designed to host a DZE series Digiflex® Performance™ digital servo drive. The drive plugs into the bottom side of the mounting card, providing a compact assembly with connectors and switches readily accessible. The MC1XDZPE01 is ideal for prototyping and integrating a DZE series digital servo drive in your machine.

The MC1XDZPE01 utilizes side-entry right angle fixed screw terminals for the motor and power connectors, and quick-disconnect signal, feedback, and communication connectors.

DZE series Digiflex® Performance™ digital servo drives communicate on an EtherCAT® network. EtherCAT is a registered trademark and patented technology, licensed by Beckhoff Automation GmbH, Germany.

Drive Compatibility

DZE 80V Drive Models

Peak Current	20 A (14.1 A _{RMS})
Continuous Current	10 A (10 A _{RMS})
Supply Voltage	18 - 80 VDC



Features

- ▲ Mounts DZE DigiFlex® Performance™ Digital Servo Drives
- ▲ Single Axis Mounting Card
- ▲ On-board Rotary Switches for Configuration and Communication Settings

DRIVES SUPPORTED

- DZEANTU-020B080

FEEDBACK SUPPORTED (DRIVE FIRMWARE DEPENDENT)

- Incremental Encoder
- Auxiliary Incremental Encoder
- Hall Sensors
- 1Vp-p Sine/Cosine Encoder
- Absolute Encoder (Heidenhain EnDat® or Stegmann Hiperface®)
- ±10 VDC Position
- Tachometer (±10 VDC)

COMPLIANCES & AGENCY APPROVALS

- RoHS

BLOCK DIAGRAM & SPECIFICATION SUMMARY

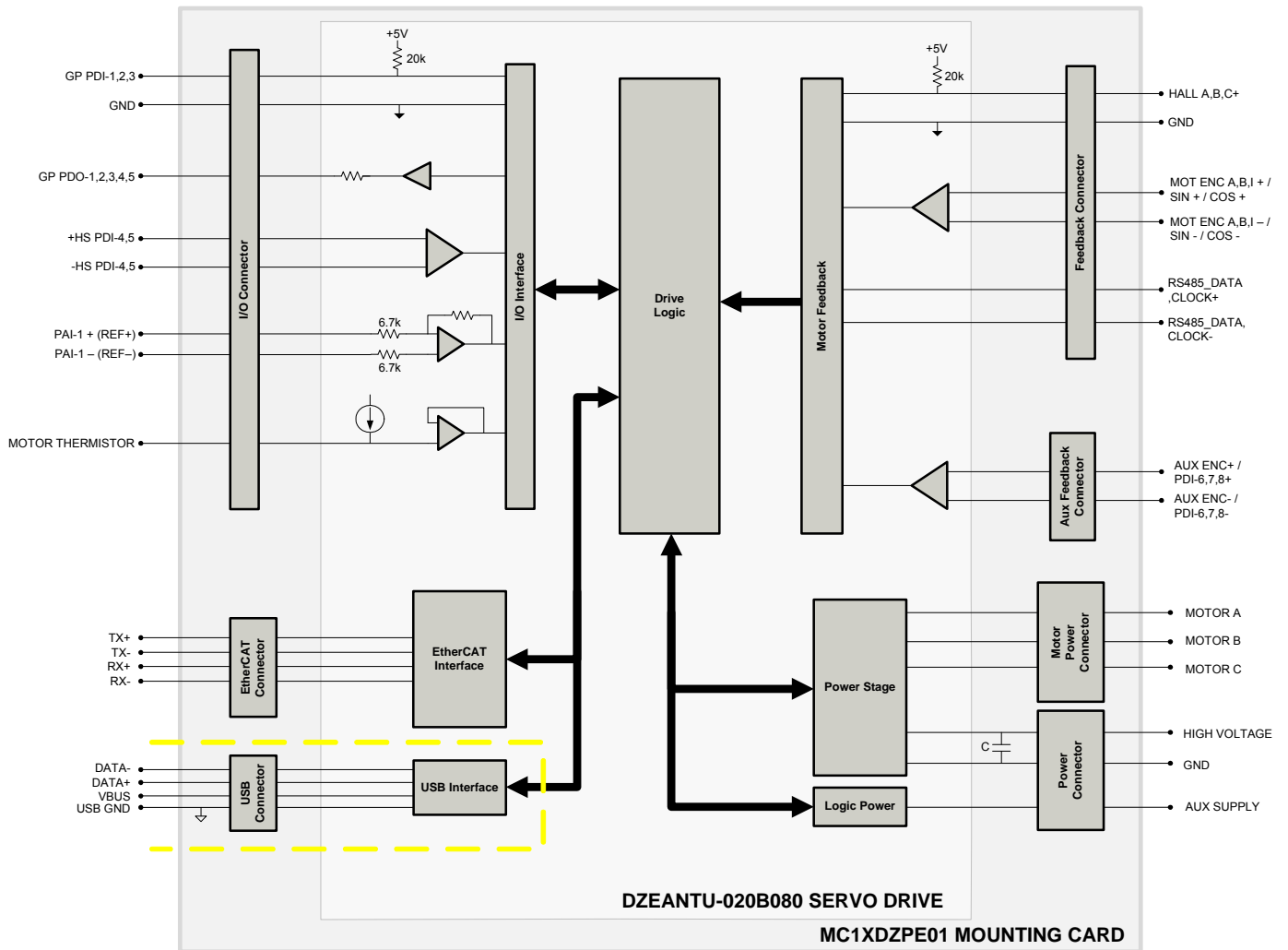

Mechanical Specifications

Mounting Signal Connector: Mates Directly to Drive	96-port, 1.27mm spaced, dual-row socket
Mounting Power Connector: Mates Directly to Drive	50-pin, 2.0mm spaced, dual-row socket
Motor Power Connector: P1	4-port screw terminal
Power Connector: P2	4-port screw terminal
EtherCAT Communication Connectors: P3/P4	Shielded, RJ-45 socket with LEDs
USB Connector: P6	5-pin, Mini USB B Type port
I/O Connector: P7*	20-pin, dual-row, 2.00 mm spaced plug terminal, vertical mount
Auxiliary Feedback Connector: P8*	10-pin, dual-row, 2.00 mm spaced plug terminal, vertical mount
Feedback Connector: P9*	18-pin, dual-row, 2.00 mm spaced plug terminal, vertical mount
Bus Capacitance	100 μ F / 200 V
Size (L x W x H) mm (in)	63.50 x 88.90 x 26.29 (2.50 x 3.50 x 1.04)
Weight g (oz)	79.4 (2.8)

***Mating Connector Kit**

Mating connector housing and crimp pins can be ordered as a kit using *ADVANCED* Motion Controls part number **KC-MC1XDZP01**. This includes mating connector housing and crimp style contacts for the I/O, Feedback, and Auxiliary Feedback connectors. The recommended tool for crimping the contacts is Molex part number **63811-6300**.

PIN FUNCTIONS

Mounting Signal Connector

This connector mates directly to the drive. Drive attaches from underside of mounting card PCB. For pin functions refer to the drive datasheet.

Mounting Power Connector

This connector mates directly to the drive. Drive attaches from underside of mounting card PCB. For pin functions refer to the drive datasheet.

P1 – Motor Power Connector

Pin	Name	Description / Notes	I/O
1	MOTOR C	Motor Phase Outputs (35A continuous maximum)	O
2	MOTOR B		O
3	MOTOR A		O
4	CHASSIS	Shield Connection.	-

P2 - Power Connector

Pin	Name	Description / Notes	I/O
1	CHASSIS	Shield Connection.	-
2	AUX SUPPLY	Logic Supply	I
3	GND	Ground.	GND
4	HV	DC Power Supply (24 A continuous maximum)	I

P3/P4 – EtherCAT Communication Connectors

Pin	Name	Description / Notes	I/O
1	TX+	Transmit Line (100 Base TX)	I/O
2	TX-		I/O
3	RX+	Receive Line (100 Base TX)	I/O
4	RESERVED	Reserved	-
5	RESERVED	Reserved	-
6	RX-	Receive Line (100 Base TX)	I/O
7	RESERVED	Reserved	-
8	CHASSIS	Shield Connection.	-

P6 - USB Communication Connector

Pin	Name	Description / Notes	I/O
1	VBUS	Supply Voltage	O
2	DATA -	USB Data -	I/O
3	DATA +	USB Data +	I/O
4	RESERVED	Reserved	-
5	GND	USB Ground	UGND

P7 – I/O Connector			
Pin	Name	Description	I/O
1	CHASSIS	Shield Connection.	-
2	RESERVED	Reserved	-
3	PDI-1	Programmable Digital Input	I
4	PDI-4+	High Speed Differential Programmable Digital Input	I
5	PDI-2	Programmable Digital Input	I
6	PDI-4-	High Speed Differential Programmable Digital Input	I
7	PDI-3	Programmable Digital Input	I
8	PDI-5+	High Speed Differential Programmable Digital Input	I
9	RESERVED	Reserved	-
10	PDI-5-	High Speed Differential Programmable Digital Input	I
11	PDO-1	Programmable Digital Output	O
12	RESERVED	Reserved	-
13	PDO-2	Programmable Digital Output	O
14	+5V OUT	+5V Output from Logic Supply	O
15	PDO-3	Programmable Digital Output	O
16	GND	Ground	GND
17	PDO-4	Programmable Digital Output	O
18	PAI-1+	Differential Programmable Analog Input or Reference Signal Input (12-bit resolution)	I
19	PDO-5	Programmable Digital Output	O
20	PAI-1-	Differential Programmable Analog Input or Reference Signal Input (12-bit resolution)	I

P8 – Auxiliary Feedback Connector			
Pin	Name	Description	I/O
1	CHASSIS	Shield Connection.	-
2	RESERVED	Reserved	-
3	AUX ENC I+	Auxiliary Incremental Encoder Channel I or Differential Programmable Digital Input 8	I
4	AUX ENC A+	Auxiliary Incremental Encoder Channel A or Differential Programmable Digital Input 6	I
5	AUX ENC I-	Auxiliary Incremental Encoder Channel I or Differential Programmable Digital Input 8	I
6	AUX ENC A-	Auxiliary Incremental Encoder Channel A or Differential Programmable Digital Input 6	I
7	+5V USER	+5V User Supply Output (current shared with pin P9-17)	O
8	AUX ENC B+	Auxiliary Incremental Encoder Channel B or Differential Programmable Digital Input 7	I
9	GND	Ground	GND
10	AUX ENC B-	Auxiliary Incremental Encoder Channel B or Differential Programmable Digital Input 7	I

P9 – Feedback Connector*					
Pin	Incremental Encoder	Absolute Encoder	1Vp-p Sin/Cos Encoder	Description / Notes	I/O
1	CHASSIS	CHASSIS	CHASSIS	Shield Connection.	-
2	RESERVED	RESERVED	RESERVED	Reserved	-
3	MOT ENC I+	RESERVED	RESERVED	Differential Encoder Index	I
4	MOT ENC A+	SIN+	SIN+	Differential Encoder A / Differential Sine Input	I
5	MOT ENC I-	RESERVED	RESERVED	Differential Encoder Index	I
6	MOT ENC A-	SIN-	SIN-	Differential Encoder A / Differential Sine Input	I
7	HALL A	RESERVED	HALL A	Commutation sensor input.	I
8	MOT ENC B+	COS+	COS+	Differential Encoder B/ Differential Cosine Input	I
9	HALL B	RESERVED	HALL B	Commutation sensor input.	I
10	MOT ENC B-	COS-	COS-	Differential Encoder B/ Differential Cosine Input	I
11	HALL C	RESERVED	HALL C	Commutation sensor input.	I
12	RESERVED	RS485_CLK+	RESERVED	Differential Clock Line	-
13	MOTOR THERMISTOR	MOTOR THERMISTOR	MOTOR THERMISTOR	Motor Thermal Protection	I/O
14	RESERVED	RS485_CLK-	RESERVED	Differential Clock Line	I/O
15	+5V USER	+5V USER	+5V USER	+5V User Supply Output (current shared with pin P8-7)	I/O
16	RESERVED	RS485_DATA+	RESERVED	Differential Data Line	I/O
17	GND	GND	GND	Ground	GND
18	RESERVED	RS485_DATA-	RESERVED	Differential Data Line	I/O

*Note: Feedback supported (Incremental Encoder, Absolute Sin/Cos Encoder, or 1Vp-p Sin/Cos Encoder) will be dependent on drive firmware.

BOARD CONFIGURATION

EtherCAT Station Alias Selector Switches

Switch Diagram	Description																								
	<p>Hexadecimal switch settings correspond to the drive Station Alias. Note that drives on an EtherCAT network will be given an address automatically based on proximity to the host. Setting the switches manually is optional, and only necessary if a fixed address is required.</p> <table border="1"> <thead> <tr> <th>SW1</th> <th>SW0</th> <th>Node ID</th> </tr> </thead> <tbody> <tr> <td>0</td> <td>0</td> <td>000</td> </tr> <tr> <td>0</td> <td>1</td> <td>001</td> </tr> <tr> <td>0</td> <td>2</td> <td>002</td> </tr> <tr> <td>...</td> <td>...</td> <td>...</td> </tr> <tr> <td>F</td> <td>D</td> <td>253</td> </tr> <tr> <td>F</td> <td>E</td> <td>254</td> </tr> <tr> <td>F</td> <td>F</td> <td>255</td> </tr> </tbody> </table>	SW1	SW0	Node ID	0	0	000	0	1	001	0	2	002	F	D	253	F	E	254	F	F	255
SW1	SW0	Node ID																							
0	0	000																							
0	1	001																							
0	2	002																							
...																							
F	D	253																							
F	E	254																							
F	F	255																							

Power LED Functions

The MC1XDZPE01 features LEDs on the PCB that indicate DC Power Supply status (P), Logic Power Supply status (L), and the drive Bridge status (STS). The Power LED will light up green when power is applied to pin P2-4 (High Voltage), and the Logic LED will light up green when the Logic Power is applied to pin P2-2 (Aux Supply). The Bridge Status LED indicates the servo drive's power bridge state, and will be green when the drive is enabled, and red when the drive is in a fault state.

Communication LED Functions (on RJ-45 Communication Connectors)

LINK LED		
LED State	Description	
Green – On	Valid Link - No Activity	
Green – Flickering	Valid Link - Network Activity	
Off	Invalid Link	

STATUS LED		
RUN States		
LED State	Description	
Green – On	The device is in the state OPERATIONAL	
Green – Blinking (2.5Hz – 200ms on and 200ms off)	The device is in the state PRE-OPERATIONAL	
Green – Single Flash (200ms flash followed by 1000ms off)	The device is in state SAFE-OPERATIONAL	
Green – Flickering (10Hz – 50ms on and 50ms off)	The device is booting and has not yet entered the INIT state or The device is in state BOOTSTRAP or Firmware download operation in progress	
Off	The device is in state INIT	

ERROR LED		
LED State	Description	Example
Red – On	A PDI Watchdog timeout has occurred.	Application controller is not responding anymore.
Red – Blinking (2.5Hz – 200ms on and 200ms off)	General Configuration Error.	State change commanded by master is impossible due to register or object settings.
Red – Flickering (10Hz – 50ms on and 50ms off)	Bootling Error was detected. INIT state reached, but parameter "Change" in the AL status register is set to 0x01:change/error	Checksum Error in Flash Memory.
Red – Single Flash (200ms flash followed by 1000ms off)	The slave device application has changed the EtherCAT state autonomously: Parameter "Change" in the AL status register is set to 0x01:change/error.	Synchronization error; device enters SAFE-OPERATIONAL automatically
Red – Double Flash (Two 200ms flashes separated by 200ms off, followed by 1000ms off)	An application Watchdog timeout has occurred.	Sync Manager Watchdog timeout.

CONNECTOR INFORMATION

Mounting Signal Connector

Connector Information	96-pin, 1.27 mm spaced, dual-row socket
Mating Connector Example	No Mating Connector Required. Mate directly to drive

Mounting Power Connector

Connector Information	50-pin, 2.0 mm spaced, dual-row socket
Mating Connector Example	No Mating Connector Required. Mate directly to drive

P1 – Motor Power Connector

Connector Information	4-port screw terminal	
Mating Connector	Details	Not Applicable
	Included with Card	Not Applicable

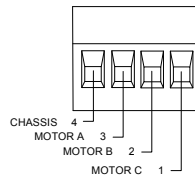

P2 – Power Connector

Connector Information	4-port screw terminal	
Mating Connector	Details	Not Applicable
	Included with Card	Not Applicable

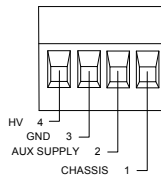

P3/P4 – EtherCAT IN/OUT Communication Connectors

Connector Information	Shielded, RJ-45 sockets with LEDs	
Mating Connector	Details	CAT 5 Cable
	Included with Card	No

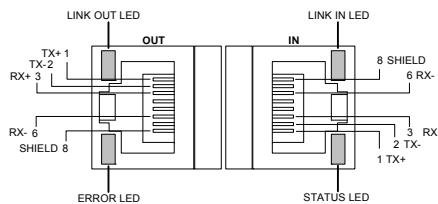

P6 – USB Connector

Connector Information		5-pin, Mini USB B Type port
Mating Connector	Details	TYCO: 1496476-3 (2-meter STD-A to MINI-B ASSY)
	Included with Card	No

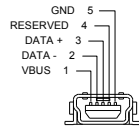

P7 – I/O Connector

Connector Information		20-pin, dual-row, 2.00 mm spaced plug terminal, vertical mount
Mating Connector	Details	Molex: P/N 51353-2000 (housing); 56134-9100 (contacts)
	Included with Card	No

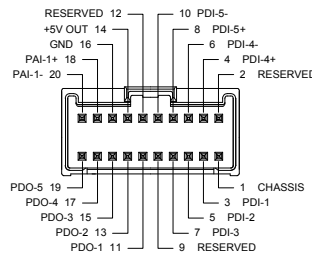

P8 – Auxiliary Feedback Connector

Connector Information		10-pin, dual-row, 2.00 mm spaced plug terminal, vertical mount
Mating Connector	Details	Molex: P/N 51353-1000 (housing); 56134-9100 (contacts)
	Included with Card	No

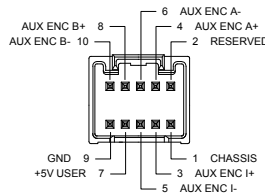

P9 – Feedback Connector

Connector Information		18-pin, dual-row, 2.00 mm spaced plug terminal, vertical mount
Mating Connector	Details	Molex: P/N 51353-1800 (housing); 56134-9100 (contacts)
	Included with Card	No

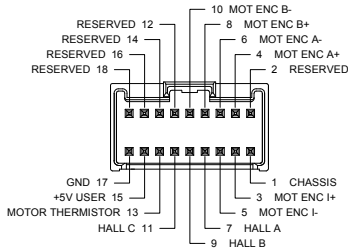

Incremental Encoder

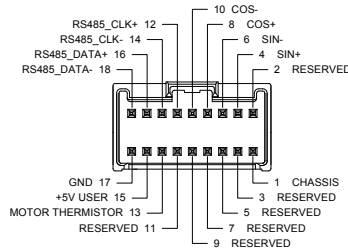

Absolute Encoder

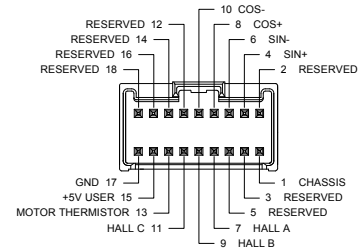

1Vp-p Sin/Cos Encoder

MOUNTING DIMENSIONS

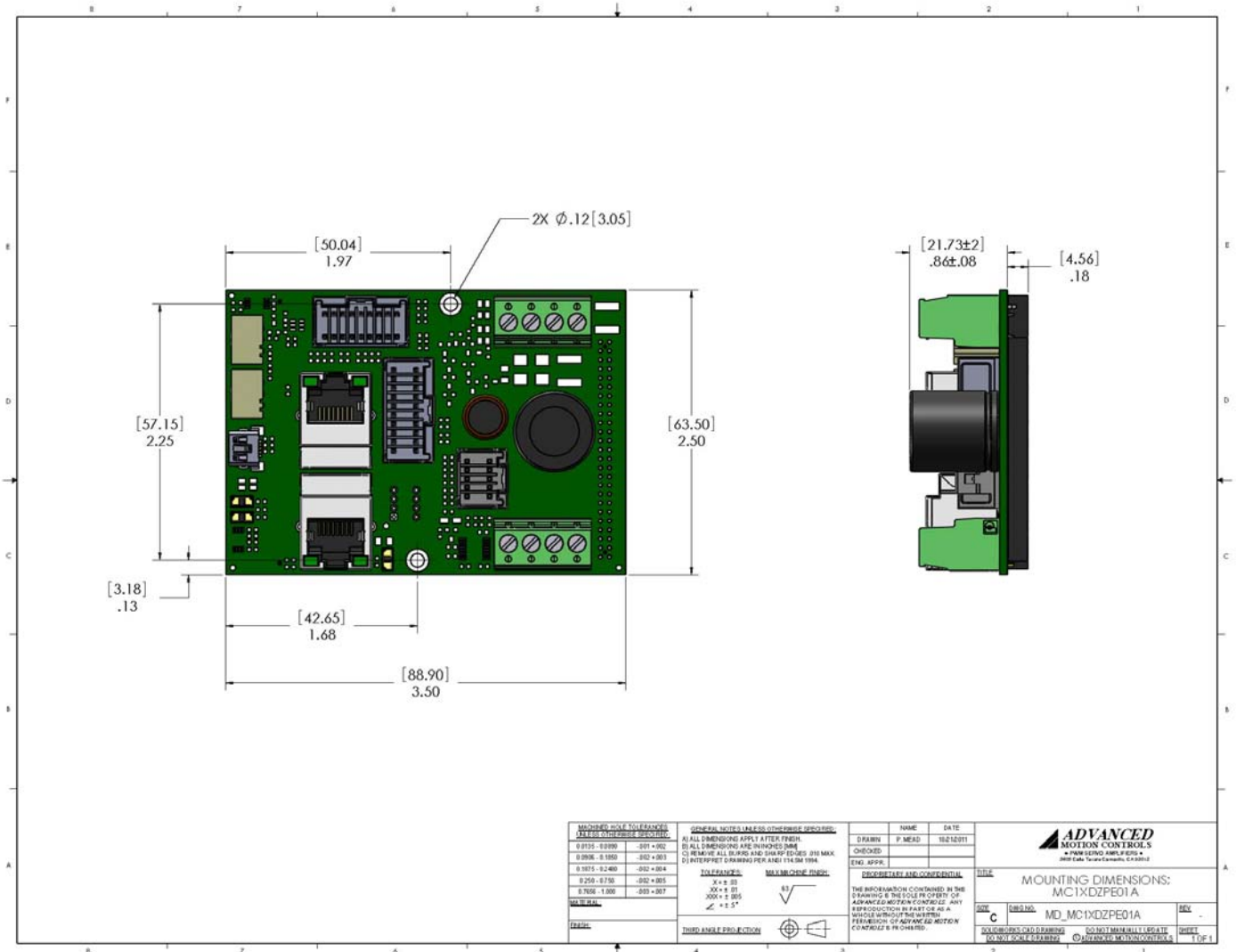

MOUNTING CONFIGURATION

Note that a DZE servo drive plugs into the MC1XDZPE01 from the underside of the mounting card to allow easy access to the mounting card switches and connectors. The drive and mounting card assembly can be secured to a panel or heatsink through the mounting holes in the drive baseplate and the sides of the mounting card.

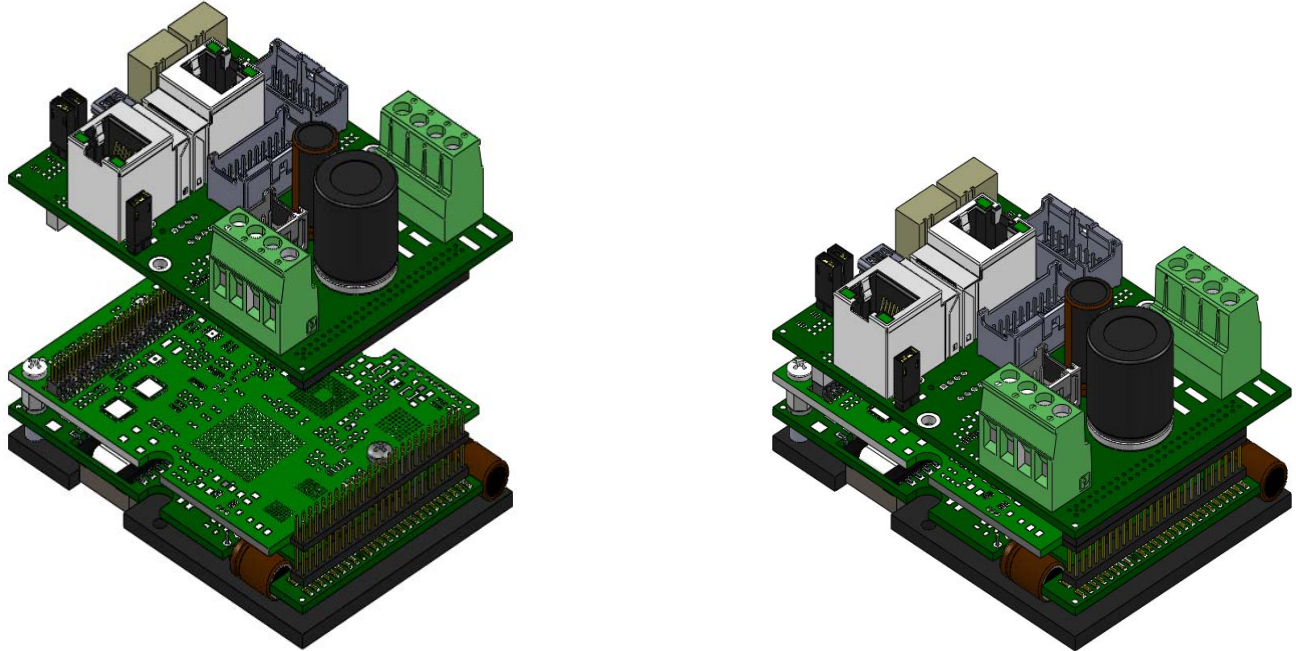

The mounting card chassis should be secured to the drive baseplate by using the two spacers included with the MC1XDZPE01 between the MC1XDZPE01 mounting holes and the drive baseplate as shown in the below image.

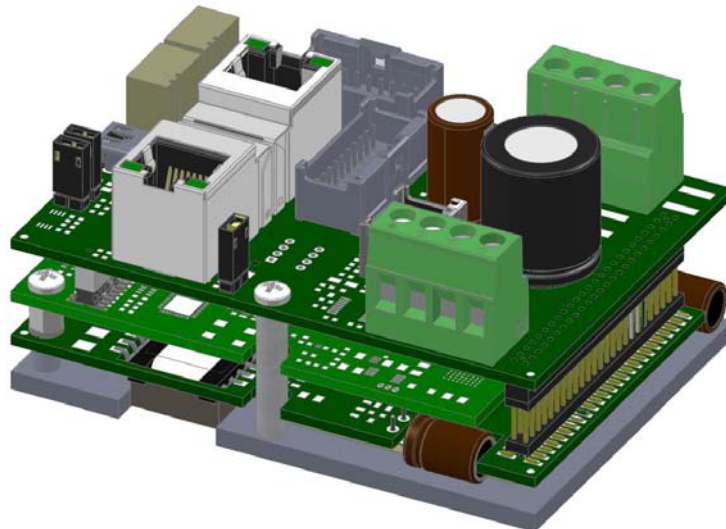

PART NUMBERING INFORMATION

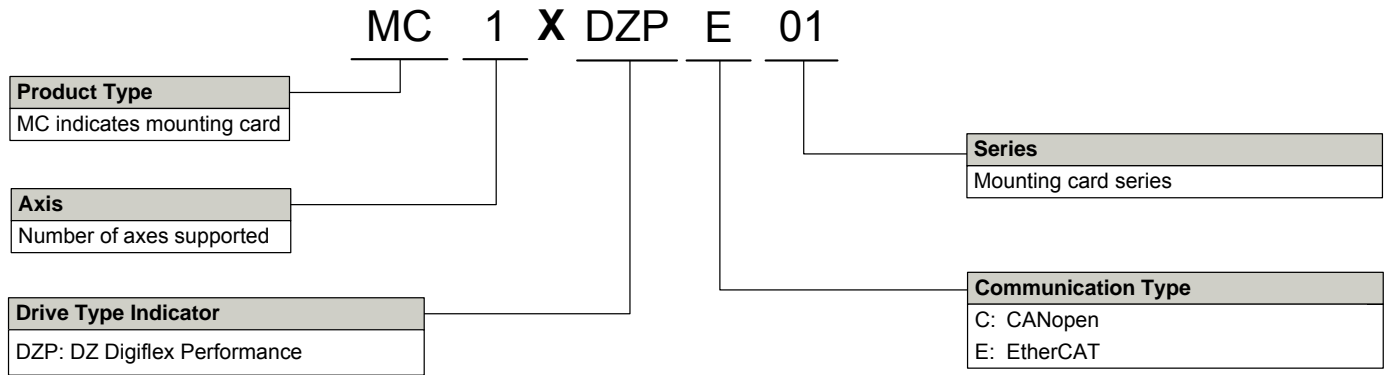

DigiFlex® Performance™ series of products are available in many configurations. All models listed in the selection tables of the website are readily available, standard product offerings.

ADVANCED Motion Controls also has the capability to promptly develop and deliver specified products for OEMs with volume requests. Our Applications and Engineering Departments will work closely with your design team through all stages of development in order to provide the best servo drive solution for your system. Equipped with on-site manufacturing for quick-turn customs capabilities, ADVANCED Motion Controls utilizes our years of engineering and manufacturing expertise to decrease your costs and time-to-market while increasing system quality and reliability.

Examples of Customized Products

- ▲ Optimized Footprint
- ▲ Private Label Software
- ▲ OEM Specified Connectors
- ▲ No Outer Case
- ▲ Increased Current Resolution
- ▲ Increased Temperature Range
- ▲ Custom Control Interface
- ▲ Integrated System I/O
- ▲ Tailored Project File
- ▲ Silkscreen Branding
- ▲ Optimized Base Plate
- ▲ Increased Current Limits
- ▲ Increased Voltage Range
- ▲ Conformal Coating
- ▲ Multi-Axis Configurations
- ▲ Reduced Profile Size and Weight

Feel free to contact Applications Engineering for further information and details.

All specifications in this document are subject to change without written notice. Actual product may differ from pictures provided in this document.