

Model 771



Features

- Large Bore size to 1.875" or 43 mm
- Fits NEMA Size 182TC Thru 256TC Motor Faces (8.5" AK)
- Incorporates Opto-ASIC Technology
- Resolutions to 4096 CPR

The Model 771 C-face encoder is a rugged, high resolution encoder designed to mount directly on NEMA C-face motors. Both sides of the encoder are C-face mounts, allowing additional C-face devices to be easily mounted. Many competitive C-face units are kit type encoders, but the Model 771 contains precision bearings and an internal flex mount that virtually eliminates encoder failures and inaccuracies induced by motor shaft runout or axial endplay. The advanced Opto-ASIC design provides superior noise immunity necessary for many industrial applications. This encoder is ideal for applications using induction motors and flux vector control. A Thru-Bore design allows fast and simple mounting of the encoder directly to the accessory shaft or drive shaft of a motor using a NEMA standard motor face (sizes 182TC - 256TC). The tough, all metal housing resists the vibration and hazards of an industrial environment.

Common Applications

Motor Feedback, Velocity & Position Control, Servo Control Systems, Assembly & Specialty Machines, Elevator Controls

Model 771 Ordering Guide

Blue type indicates price adder options. Not all configuration combinations may be available. Contact Customer Service for details.

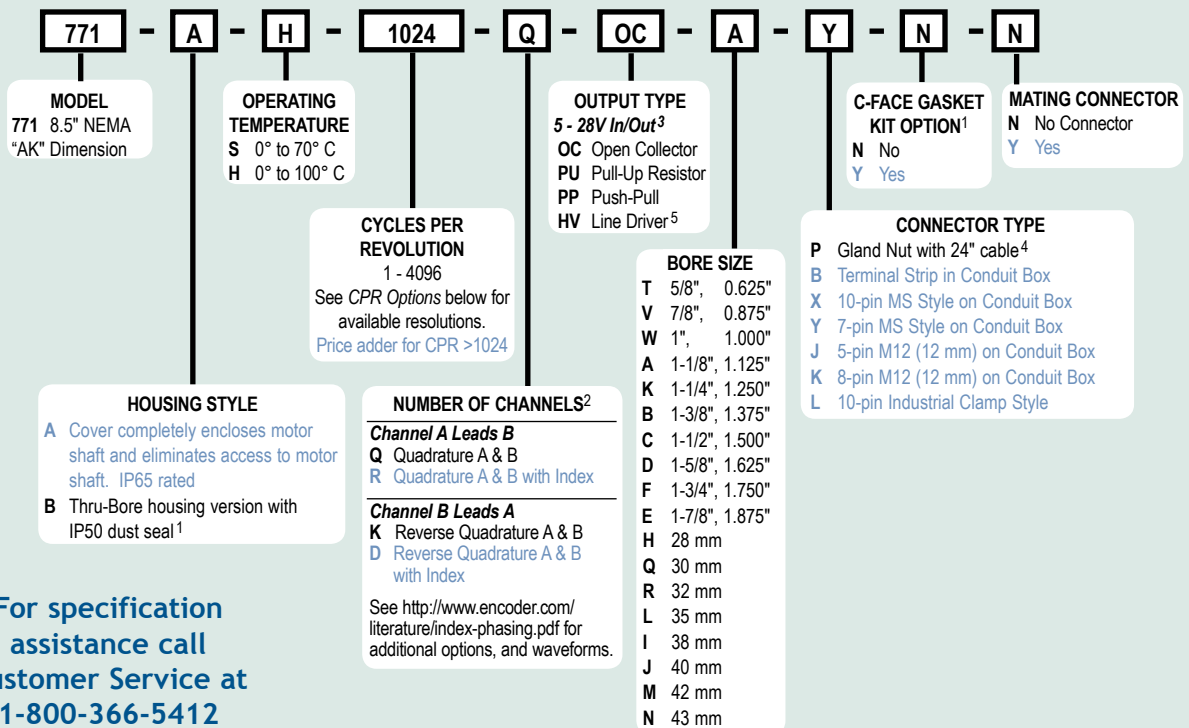

For specification assistance call
Customer Service at
1-800-366-5412

Model 771 CPR Options

0060	0100	0120	0240	0250	0256
0500	0512	0600	1000	1024	2048
2500	4096				

Contact Customer Service for other disk resolutions; not all disk resolutions available with all output types

NOTES:

- 1 Thru-Bore version may be IP65 sealed if mounted between two C-face devices with optional gasket kit. Select 'Yes' under C-face Gasket Kit Option.
- 2 Contact Customer Service for index gating options.
- 3 5 to 24 VDC max for high temperature option.
- 4 For non-standard cable lengths, add a forward slash (/) plus cable length expressed in feet. Example: P/6 = 6 feet of cable.
- 5 Not available with 5-pin M12 connector. Available with 7-pin MS connector only without Index Z.

Model 771

Model 771 Specifications

Electrical

- Input Voltage.....4.75 to 28 VDC max for temperatures up to 70° C
4.75 to 24 VDC for temperatures between 70° C to 100° C
- Input Current.....100 mA max with no output load
- Input Ripple.....100 mV peak-to-peak at 0 to 100 kHz
- Output Format.....Incremental- Two square waves in quadrature with channel A leading B for clockwise shaft rotation, as viewed from the mounting face. See *Waveform Diagrams* below.
- Output Types.....Open Collector- 100 mA max per channel
Pull-Up- 100 mA max per channel
Push-Pull- 20 mA max per channel
Line Driver- 20 mA max per channel (Meets RS 422 at 5 VDC supply)
- Index.....Once per revolution.
0475 to 4096 CPR: Gated to output A
0001 to 0474 CPR: Ungated
See *Waveform Diagrams* below.
- Max Frequency.....200 kHz
- Noise Immunity.....Tested to BS EN61000-4-2; IEC801-3; BS EN61000-4-4; DENV 50141; DENV 50204; BS EN55022 (with European compliance option); BS EN61000-6-2; BS EN50081-2
- Symmetry.....180° (±18°) electrical
- Quad. Phasing.....90° (±22.5°) electrical
- Min. Edge Sep.....67.5° electrical
- Rise Time.....Less than 1 microsecond

Mechanical

- Max Shaft Speed.....3500 RPM. Higher shaft speeds may be achievable, contact Customer Service.
- 6000 RPM for 1.125", 1.250", 1.375", 28 mm, 30 mm, 32 mm bore diameter
- Bore Size.....0.625", 0.875", 1.00", 1.125", 1.250", 1.375", 1.500", 1.625", 1.750", 1.875", 28 mm, 30 mm, 32 mm, 35 mm, 38 mm, 40 mm, 42 mm, and 43 mm
- User Shaft Tolerances
Radial Runout.....0.005"
Axial Endplay.....±0.1"
- Moment of Inertia.....3.3 x 10⁻³ oz-in-sec² typical
- Electrical Conn.....Gland nut with 24" cable (foil and braid shield, 24 AWG conductors), Terminal Strip in conduit box, 7- or 10-pin MS Style, 5- or 8-pin M12 (12 mm), 10-pin Industrial Clamp
- Housing.....All metal construction
- Mounting.....NEMA 182TC-256TC (8.5" AK)
- Weight.....7.0 lb typical

Environmental

- Operating Temp.....0° to 70° C for standard models
0° to 100° C for high temperature option
- Storage Temp.....-25° to 100° C
- Humidity.....98% RH non-condensing
- Vibration.....10 g @ 58 to 500 Hz
- Shock.....50 g @ 11 ms duration
- Sealing.....IP65 for Option A housing style with gasket kit IP50 for Option B housing style

Model 771 With Gland Nut Cable (P)

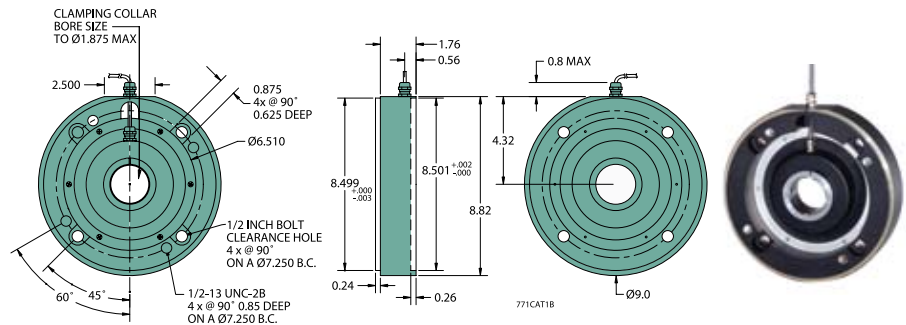

Model 771 With Conduit Box (B, X, Y, J, K)

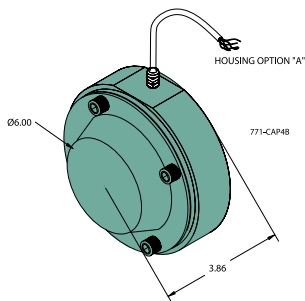
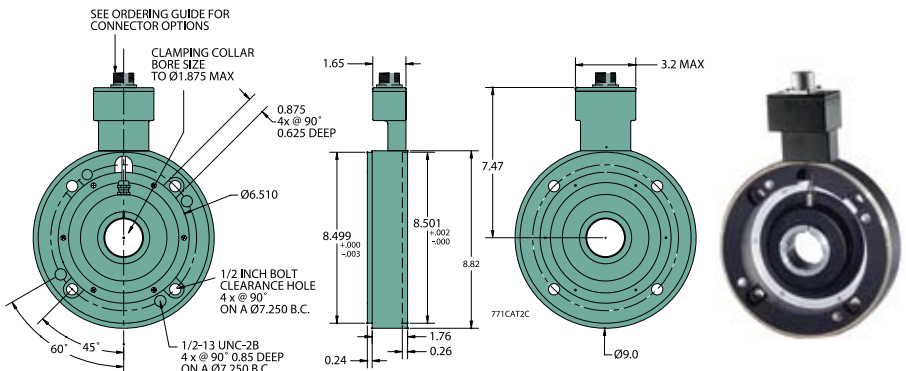

Optional Housing Style (A) Protective Cover

CONNECTOR TYPE	HEIGHT
6- or 7-PIN MS	0.67"
10-PIN MS	0.90"
5- or 8-PIN M12	0.50"

All dimensions are in inches with a tolerance of ±0.005" or ±0.01" unless otherwise specified

Waveform Diagrams

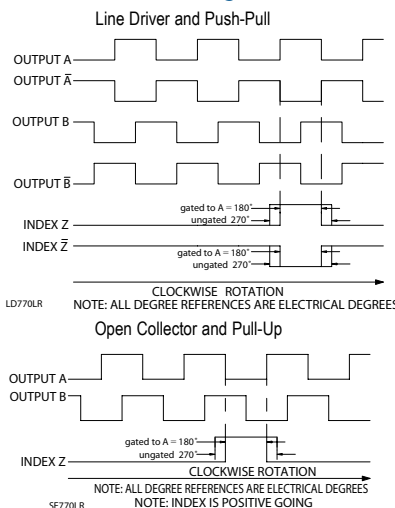

Wiring Table

Function	Gland Cable Wire Color	5-pin M12 ¹ PU, PP, OC	8-pin M12 ²	10-pin MS	7-pin MS HV	7-pin MS PU, PP, OC	Term. Block	10-pin Indust. Clamp
Com	Black	3	7	F	F	F	2	1
+VDC	Red	1	2	D	D	D	1	6
A	White	4	1	A	A	A	3	3
A'	Brown	---	3	H	C	---	4	8
B	Blue	2	4	B	B	B	5	2
B'	Violet	---	5	I	E	---	6	7
Z	Orange	5	6	C	---	C	7	4
Z'	Yellow	---	8	J	---	---	8	9
Shield	Bare ¹	---	---	---	---	---	---	---
Case	---	---	---	G ²	G ²	G ²	9 ³	10 ³

¹CE Option: Cable shield (bare wire) is connected to internal Case
²CE Option: Pin G is connected to Case
 Non CE Option: Pin G has No Connection
³CE Option: Pin 10 is connected to Case
 Non CE Option: Pin has No Connection
⁴CE Option: Read Technical Bulletin "TB111" at www.encoder.com

Incremental Thru-Bore & Motor Mount Encoders