

INDEX

ECOLINE: AFFORDABLE AND INNOVATIVE LINEAR BEARINGS.....	E4
TECHNICAL DATA AND ORDER CODES.....	E5
LOAD CAPACITIES.....	E6
SETTING SLIDER PRELOAD AND ROLLER ORIENTATION.....	E7
MOUNTING EXAMPLES.....	E7
SQUARE MOUNTING NUTS FOR “T” SLOTS.....	E7
ENDCAPS.....	E7
“XM” VERSION (LINEAR UNIT).....	E8
MOTOR INTERFACE PLATE.....	E10

ECOLINE: AFFORDABLE AND INNOVATIVE LINEAR BEARINGS

ECOLINE's products have been designed to fit in applications where **quality movement** is needed at a low price. The patented design offers a **well-protected, smooth slide that is easily and quickly mounted**. **ECOLINE** combines the quality associated with all of **ROLLON's** products with the affordability needed in application sectors like industrial protective panels, vehicle slides, and machine tool doors. **ECOLINE** is the answer to labor intensive, homemade solutions, cheap bent steel slides, or expensive, oversized round or profiled shafting.

The rail, normally mounted to the fixed part of the machine, is a specially designed **anodized aluminum** extrusion. The steel slider body, normally mounted to the moving structure, has six radial ball-bearing "rollers" mounted in such a way as to allow **optimal contact on the four internal raceways**. The linear contact between the rollers and the raceways minimizes wear and maximizes load capacity, assuring a long lifetime. The patented design of the two-piece slider allows the cross-mounted rollers to run *inside* the load-carrying aluminum rail **without play**. It also allows the fast and simple setting of preload. With the **XSP** version, the orientation of some of the rollers can even be inverted, allowing the inversion of the preferential load direction.

Keeping in mind the unclean nature of many of **ECOLINE's** main application sectors, **the products were designed to keep damaging dirt and particles out**. The contact between the rollers and the raceways occurs inside the specially shaped profile, protected **from accidental impacts and from debris** and impurities. Longitudinal protective belts, which **limit the possible infiltration of dust and dirt** along the thin slot where the slider travels, are available as well. When ordered as a complete unit with slider mounted inside the rail, protective tecnopolimer endcaps are supplied.

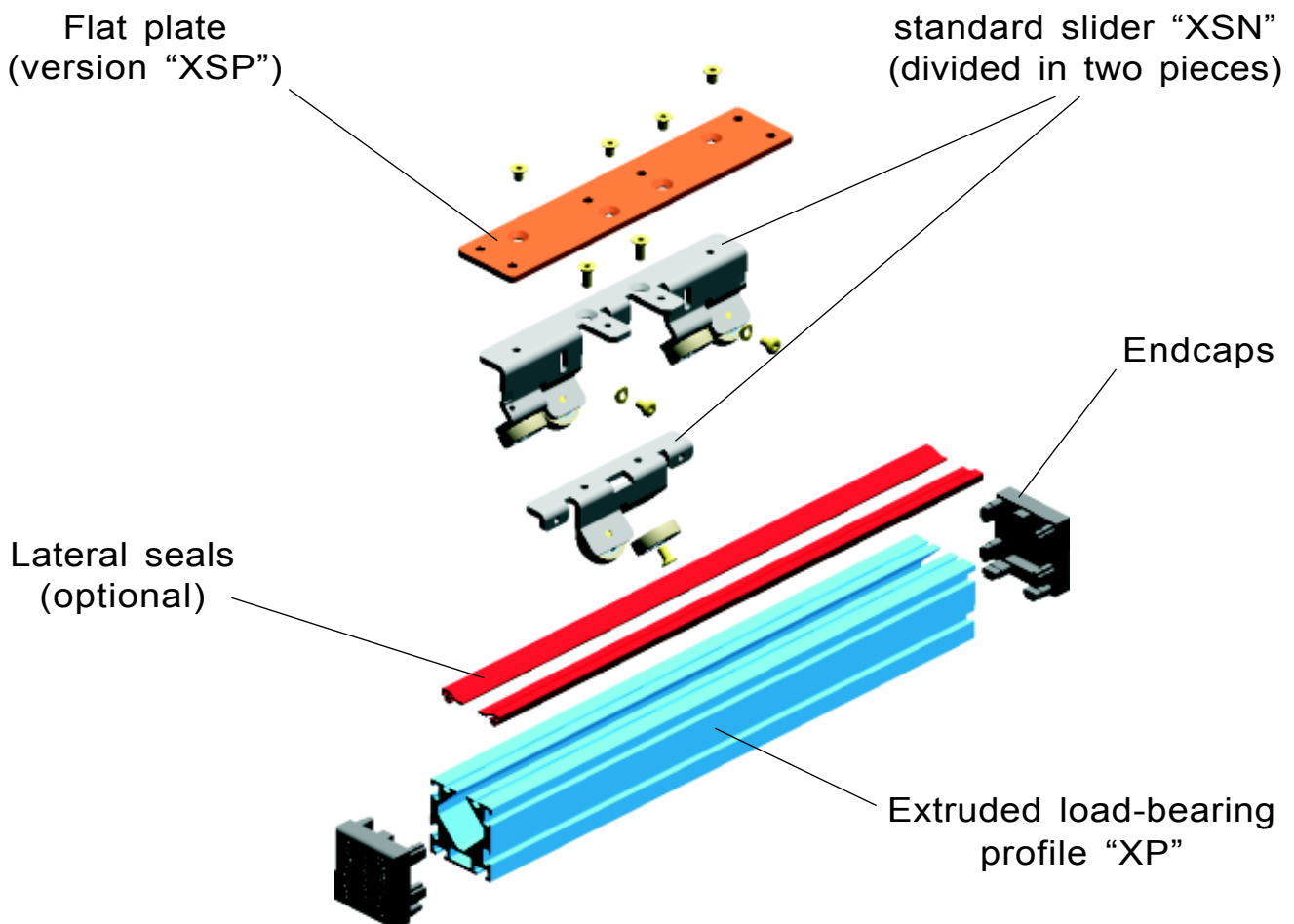

TECHNICAL DATA AND ORDER CODES

Rails and sliders can be ordered separately or together in mounted sets.

• XP37 - ALUMINUM PROFILE

The available lengths **L** of the **XP37** profile range from 250 mm to 6000 mm with 10 mm intervals (250, 260, 270, ..., ..., 5980, 5990, 6000 mm).

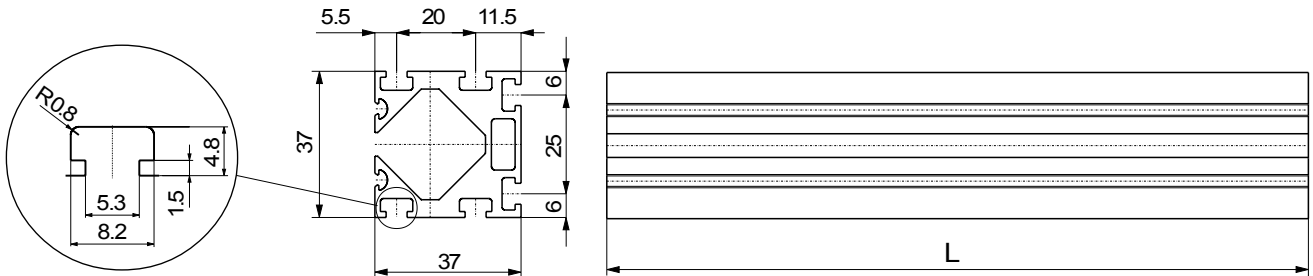

Six slots for thin square M5 nuts UNI 5596

Order Code:

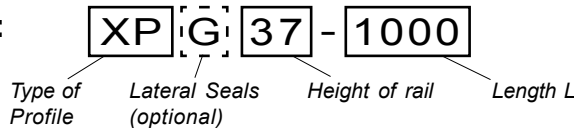

Profile XP37 weight:
1500 g/m

• SLIDER

The slider is available in two versions, standard (**XSN37**) and with optional mounting plate (**XSP37**). For operation differences, see next page.

- STANDARD SLIDER "XSN37":

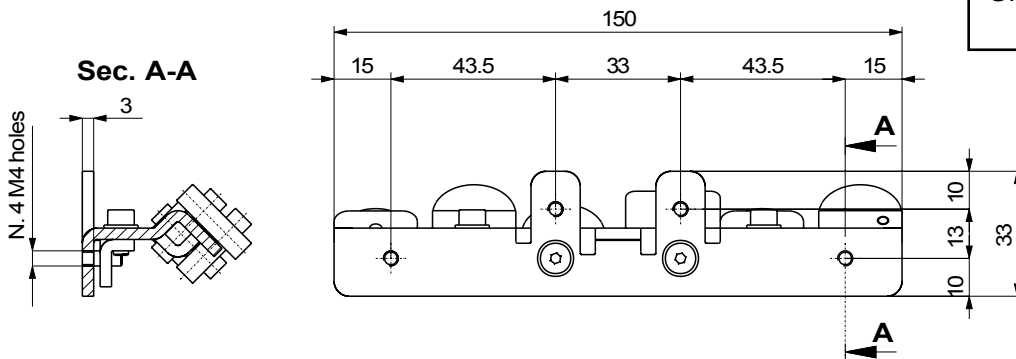

Slider XSN37 weight:
255 g

Order Code:



- SLIDER WITH FLAT PLATE "XSP37":

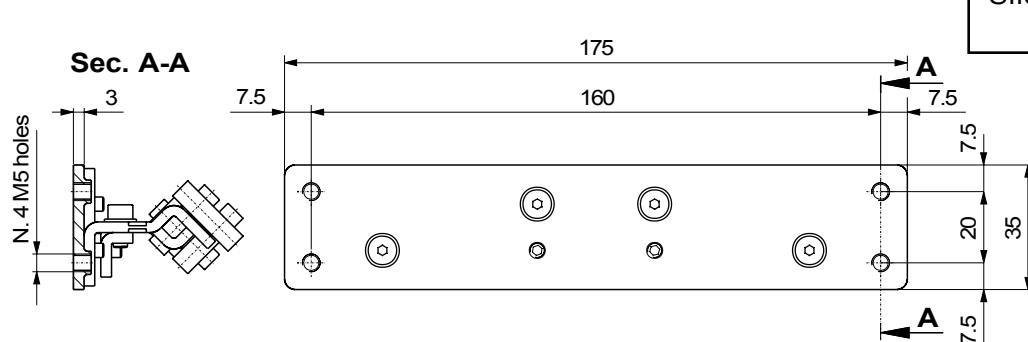

Slider XSP37 weight:
395 g

Order Code:

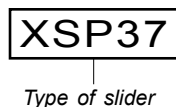

• MOUNTED SLIDER/RAIL SET

When desired, sliders can be shipped mounted and preloaded in the rail. In these cases, the rails will also come with endcaps mounted on the ends of the **XP37** profile.

- “XP37” PROFILE and STANDARD SLIDER “XSN37”:

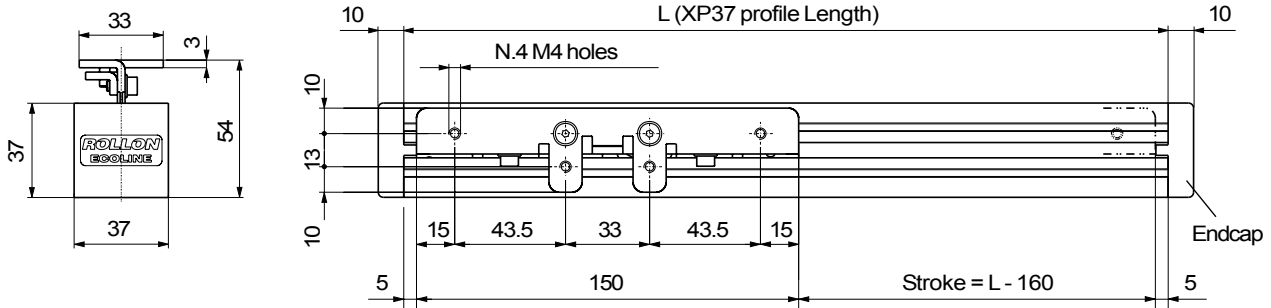

- “XP37” PROFILE and SLIDER WITH FLAT PLATE “XSP37”:

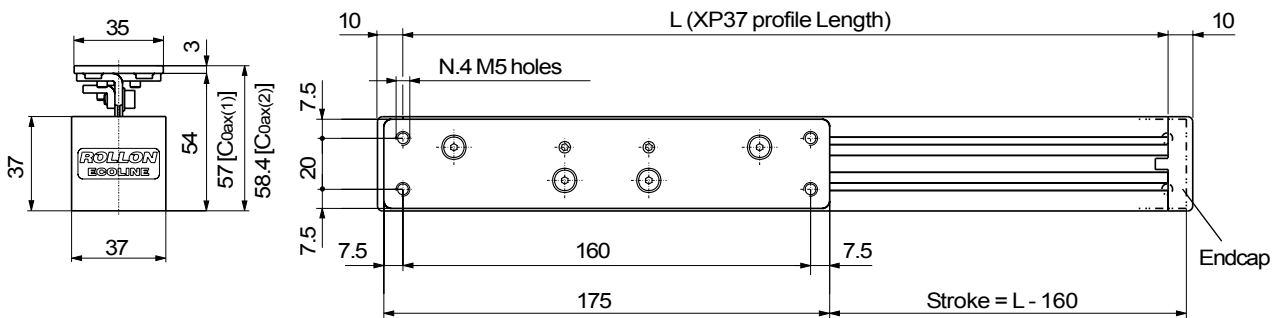

Order Code:

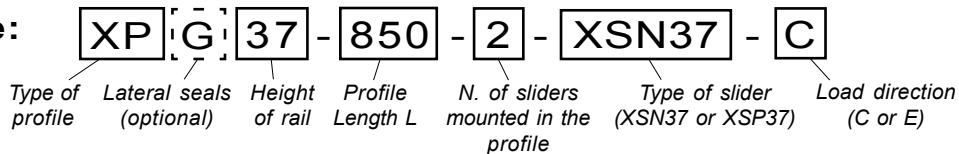

LOAD CAPACITIES

ECOLINE products work best in terms of load capacity, rigidity, and lifetime, when the external load acts axially on the slider. The load for the standard slider units (**XSN37**) must be applied in the “C0ax(1)” direction as shown below. The preferential load direction for the flat plate units (**XSP37**) can actually be modified by simply adjusting the direction of the internal rollers. The simple procedure (see next page) allows **XSP37** to work equally well in either the “C0ax(1)” or “C0ax(2)” direction depending on the orientation of the rollers*.

Type of slider	C _{0ax(1)} [N] Load direction “C”	C _{0ax(2)} [N] Load direction “E”
XSN37 (standard)	300	0
XSP37 (with flat plate)*	300	300

*The applicable load can be either “C0ax(1)” or “C0ax(2)” but never both simultaneously.

Standard slider XSN37:

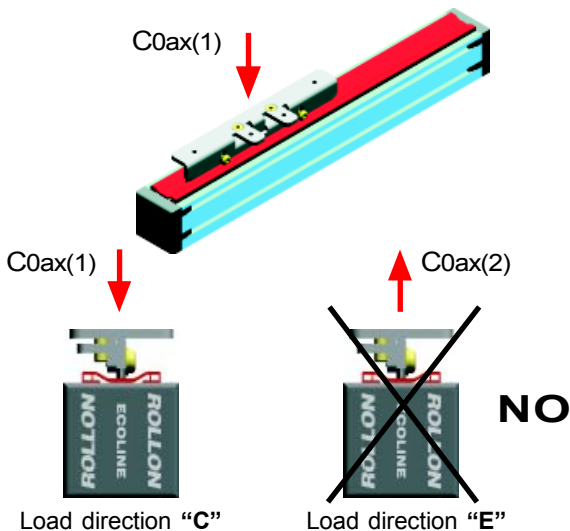

Slider with flat plate XSP37:

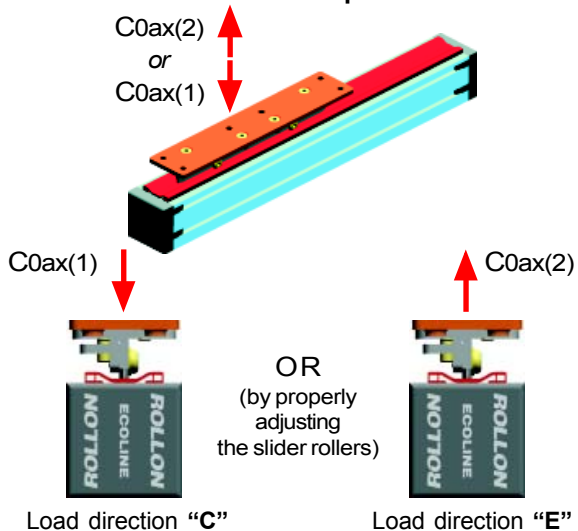

SETTING SLIDER PRELOAD AND ROLLER ORIENTATION

• Using standard XSN37 sliders:

As indicated on the previous page, the standard slider (XSN37) can only be utilized with the load applied in the "C0ax(1)" direction. To set the slider preload inside of the rail profile, follow the instructions listed below.

1. Loosen blocking screws "a" in order to modify the position of one part of the slider relative to the other;
2. Tighten screws "b" until the correct preload (based on desired slide quality) is achieved;
3. Securely tighten screws "a" to block the two parts of the slider in the desired position.

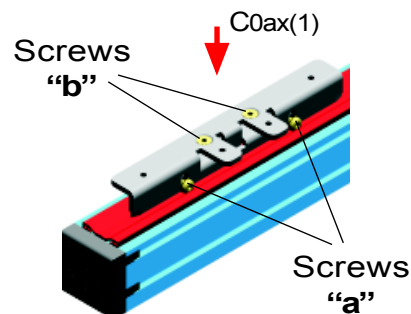

• Using XSP37 sliders with flat plate:

XSP37 sliders can be used in either "C0ax(1)" or "C0ax(2)" directions (see explanation on previous page). To set the slider preload inside of the rail profile or to adjust the preferential load direction, follow the instructions listed below.

1. Loosen blocking screws "a" in order to modify the position of one part of the slider relative to the other;
2. Act on screws "b" (passing through the holes in the flat plate), tightening, in the case of "C0ax(1)", or loosening, in the case of "C0ax(2)", until the correct preload (based on desired slide quality) is achieved;
3. Securely tighten screws "a" to block the two parts of the slider in the desired position.

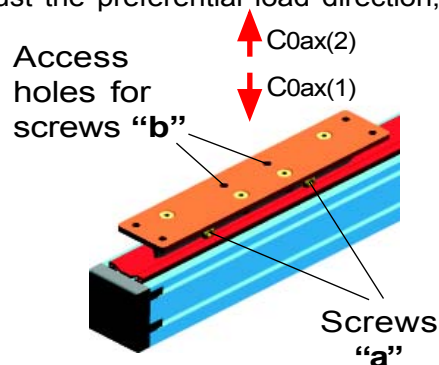

MOUNTING EXAMPLES

A typical ECOLINE application could be a protective enclosure or machine tool door. The preferred mounting configuration in these cases would have the XP37 aluminum profile mounted to the top of the fixed structure with two XSP37 sliders with flat plate (correctly positioned and preloaded) mounted to the top of moving structure. Another XP37 aluminum profile (rotated 90° in relation to the first) could be mounted to lower part of the fixed structure. Two XSN37 sliders mounted to the lower part of the moving structure would be correctly positioned and preloaded in the rail. This second unit would act against any overturning moments. In both cases, the ECOLINE units are always positioned so that the loads act axially on the sliders.

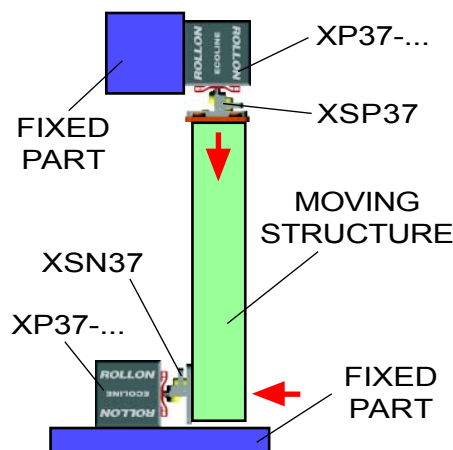

SQUARE MOUNTING NUTS FOR "T" SLOTS

The integral "T" slots in the XP37 profiles facilitate the quick and easy mounting of the units. Square mounting nuts for these integral "T" slots are available in boxes of 100 pieces. The order code is: **ACX37-001**.

ENDCAPS

When units are ordered with preloaded sliders mounted in them, an endcap is mounted to each end of the rail. If rail profiles and sliders are ordered separately, endcaps can also be ordered. Packages of 10 endcaps are available; the order code is: **ACX37-002**.

“XM” VERSION (LINEAR UNIT)

ECOLINE actuators are the most affordable linear actuators available. When **UNILINE** actuators are more than the application requires and yet homemade solutions don't make sense, **ECOLINE**'s belt-driven units are the answer. Well thought out and inexpensive, these actuators allow designers to simply and reliably automate movements that do not require excessive precision and rigidity. The six radial ball-bearing rollers run on the specially designed races inside the anodized aluminum extrusion. A toothed belt connect a pulley on each end.

The **ECOLINE** actuator is designed to be easily mounted to modular aluminum profiles. The simplicity and utility of the design make it perfect for many applications.

ECOLINE actuators are the alternative to labor intensive, homemade solutions, and expensive linear actuators that are overkill technically and don't fit into smaller budgets.

Like all of Rollon's products, these actuators have been designed to solve problems.

ECOLINE belt-driven actuators are inexpensive yet durable. Each unit has identical heads and can therefore be driven from either side. Drive shaft housings can be metric or standard. Units can also be equipped with double moving carriages.

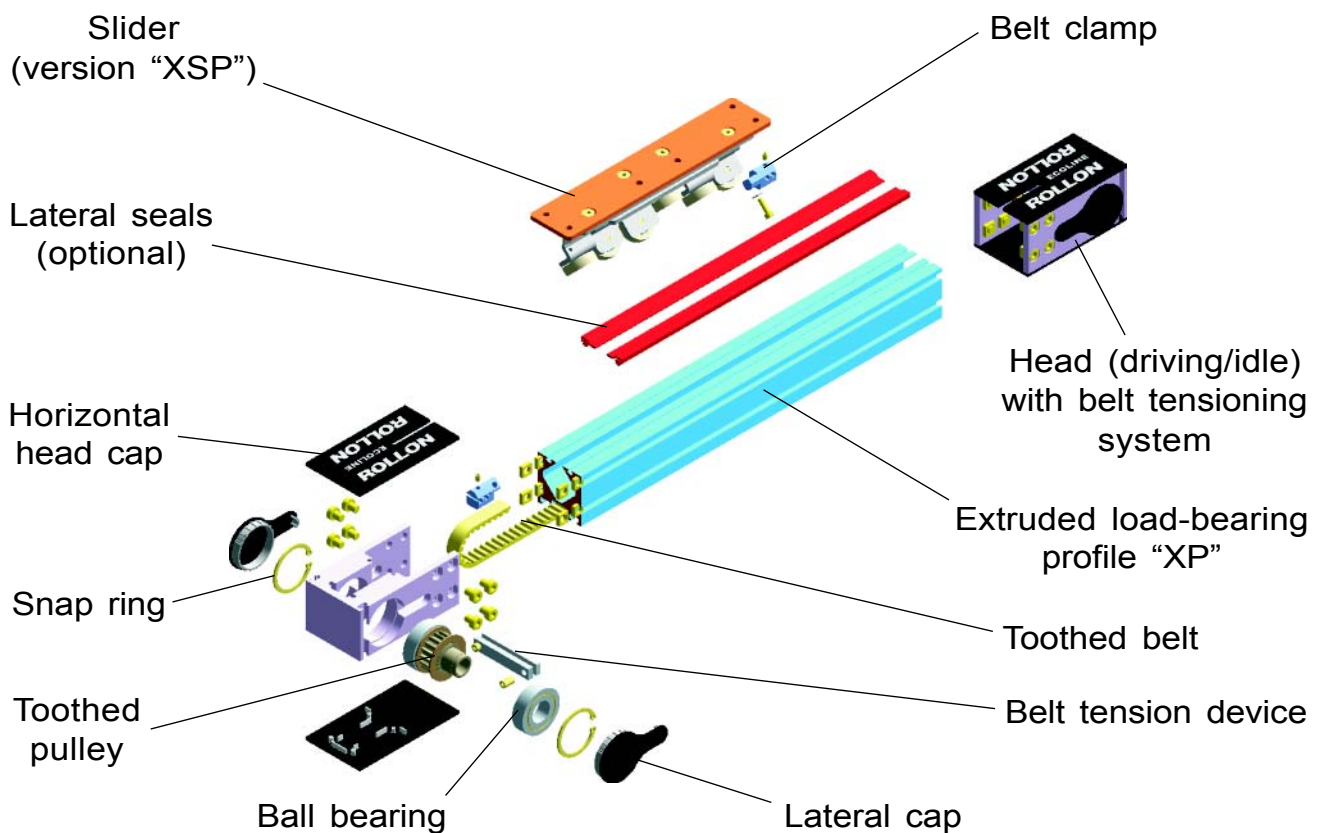

- “XM37” WITH SINGLE SLIDER “XSP37”:

Order Code:

XM	[G]	37	-	850	-	C	-	[P]
----	-----	----	---	-----	---	---	---	-----

Series Lateral seals (optional) Height of rail Stroke (in mm) Load direction (C or E) Version with pulley shaft housing in inches

- “XM37” WITH DOUBLE SLIDER “XSP37”:

Order Code:

XM	[G]	37	-	850	-	196	-	D	-	C	-	[P]
----	-----	----	---	-----	---	-----	---	---	---	---	---	-----

Series Lateral seals (optional) Height of rail Stroke (in mm) Distance between slider centers (in mm) Double slider version Load direction (C or E) Version with pulley shaft housing in inches

