

Quick Reference NEMA size 23 1.8° 2-phase stepper motor

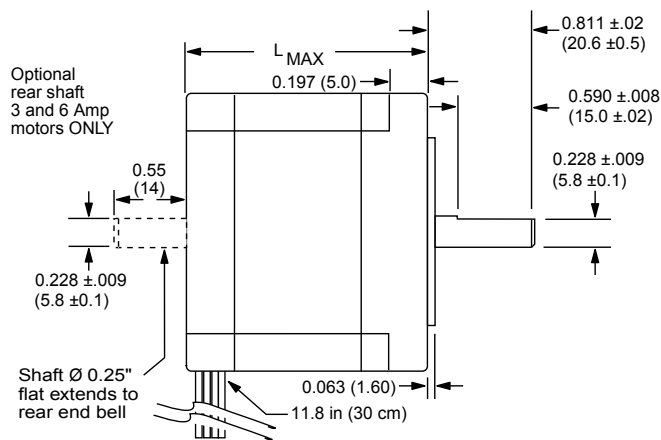

Mechanical Specifications

Dimensions in inches (mm)



FRONT VIEW

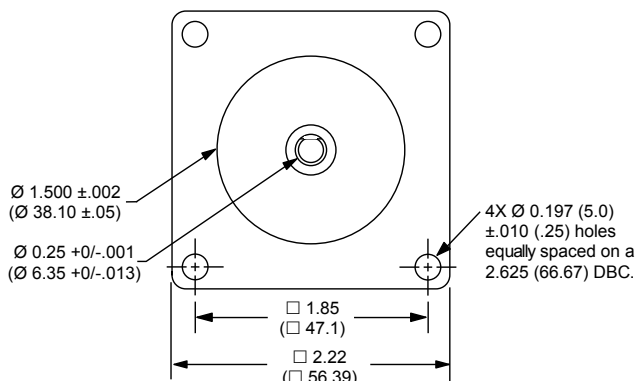

REAR VIEW (reduced)

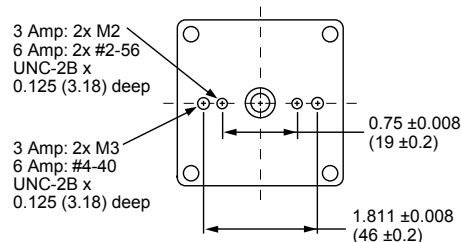

Motor stack length inches (mm)	2.4 Amp motors	3.0 Amp motors	6.0 Amp motors
Single	1.77 (45)	1.77 (45)	1.75 (44.5)
Double	2.13 (54)	2.13 (54)	2.2 (56)
Triple	2.99 (76)	2.99 (76)	3.09 (78.5)

Notes and Warnings

Installation, configuration and maintenance must be carried out by qualified technicians only. You must have detailed information to be able to carry out this work.

- Unexpected dangers may be encountered when working with this product!
- Incorrect use may destroy this product and connected components!

For more information, go to www.imshome.com

Specifications

2.4 Amp motors		Single length	Double length	Triple length
Part number		M-2218-2.4S (1)	M-2222-2.4S (1)	M-2231-2.4S (1)
Holding torque	oz-in	90	144	239
	N-cm	64	102	169
Detent torque	oz-in	3.9	5.6	9.7
	N-cm	2.7	3.9	6.9
Rotor inertia	oz-in-sec ²	0.00255	0.00368	0.0065
	kg-cm ²	0.18	0.26	0.468
Weight	oz	16.9	21.2	35.3
	grams	480	600	1000
Phase current	amps	2.4	2.4	2.4
Phase resistance	ohms	0.95	1.2	1.5
Phase inductance	mH	2.4	4.0	5.4

(1) Only available with single shaft.

3.0 Amp motors		Single length	Double length	Triple length
Part number		M-2218-3.0 (1)	M-2222-3.0 (1)	M-2231-3.0 (1)
Holding torque	oz-in	90	144	239
	N-cm	64	102	169
Detent torque	oz-in	3.9	5.6	9.7
	N-cm	2.7	3.9	6.9
Rotor inertia	oz-in-sec ²	0.00255	0.00368	0.0065
	kg-cm ²	0.18	0.26	0.468
Weight	oz	16.9	21.2	35.3
	grams	480	600	1000
Phase current	amps	3.0	3.0	3.0
Phase resistance	ohms	0.65	0.85	0.95
Phase inductance	mH	1.5	2.6	3.36

(1) Indicate S for single-shaft or D for double-shaft. Example M-2218-3.0S

6.0 Amp motors		Single length	Double length	Triple length
Part number		M-2218-6.0 (1)	M-2222-6.0 (1)	M-2231-6.0 (1)
Holding torque	oz-in	100	150	257
	N-cm	71	106	181
Detent torque	oz-in	2.0	3.0	5.0
	N-cm	1.4	2.1	3.5
Rotor inertia	oz-in-sec ²	0.0017	0.00397	0.0068
	kg-cm ²	0.12	0.28	0.48
Weight	oz	16.6	24.7	35.3
	grams	470	700	1000
Phase current	amps	6.0	6.0	6.0
Phase resistance	ohms	0.16	0.19	0.23
Phase inductance	mH	0.47	0.73	1.04

(1) Indicate S for single-shaft or D for double-shaft. Example M-2218-6.0S

Wiring and Connections

Signals and wire colors	2.4 Amp motors	3.0 Amp motors	6.0 Amp motors
Phase A	Red	Red	Black
Phase /A	White/red	White/red	Orange
Phase B	Green	Green	Red
Phase /B	White/green	White/green	Yellow

Part Numbers

Example:	M - 2 2 1 8 - 2 . 4 S
Stepper motor frame size	M - 2 2 1 8 - 2 . 4 S
M-22 = NEMA 23 (2.3"/57 mm)	
Motor length	M - 2 2 1 8 - 2 . 4 S
18- = single stack	
22- = double stack	
31- = triple stack	
Phase current	M - 2 2 1 8 - 2 . 4 S
2.4 = 2.4 Amps (1)	
3.0 = 3.0 Amps	
6.0 = 6.0 Amps	
Shaft	M - 2 2 1 8 - 2 . 4 S
S = single, front shaft only	
D = double, front and rear shafts	
Optional optical encoder (2)	M - 2 2 1 8 - 2 . 4 E S 1 0 0
ES = Single-end	
ED = Differential	
Line count	
100, 200, 250, 400, 500 or 1000 (3)	

(1) Only available with single shaft.

(2) An encoder replaces the shaft designator in the part number.

(3) All encoders have an index mark, except the 1000 line count version.

Torque-speed Performance

Measured at the rated phase current of the motor (RMS)

2.4 Amp motors

M-2218-2.4

Torque in Oz - In (N-cm)

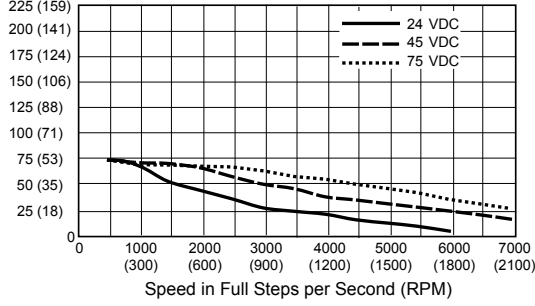

M-2222-2.4

Torque in Oz - In (N-cm)

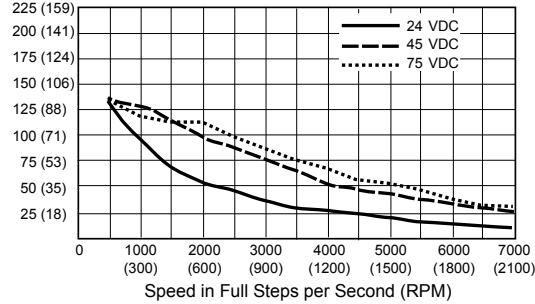

M-2231-2.4

Torque in Oz - In (N-cm)

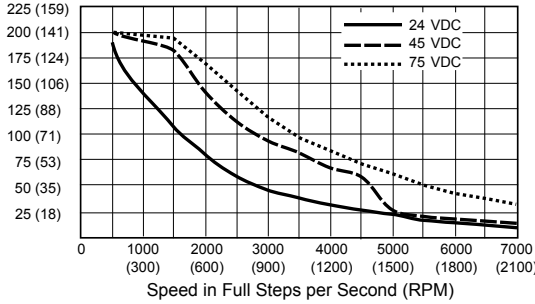

3.0 Amp motors

M-2218-3.0

Torque in Oz - In (N-cm)

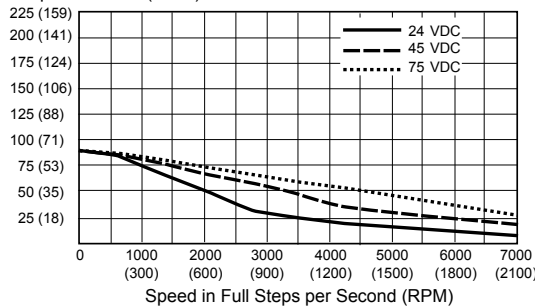

M-2222-3.0

Torque in Oz - In (N-cm)

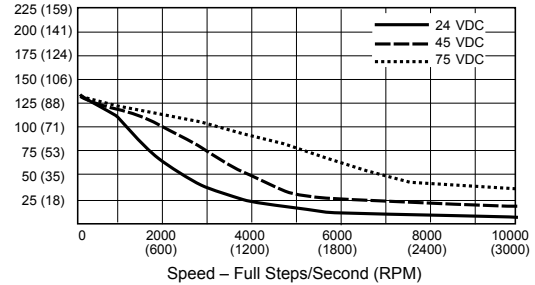

M-2231-3.0

Torque in Oz - In (N-cm)

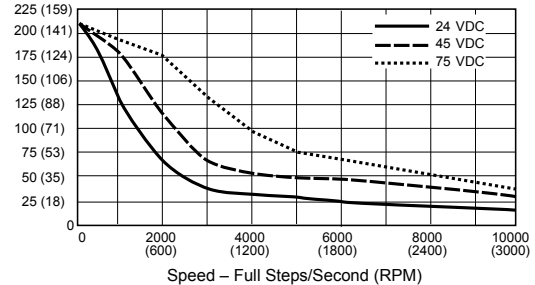

6.0 Amp motors

M-2218-6.0

Torque in Oz - In (N-cm)

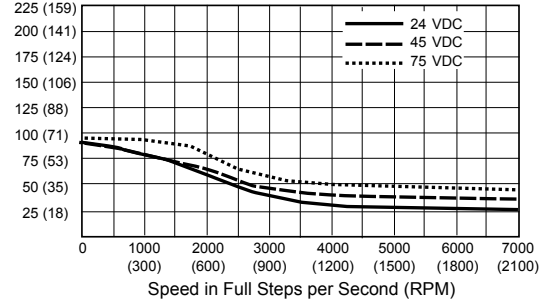

M-2222-6.0

Torque in Oz - In (N-cm)

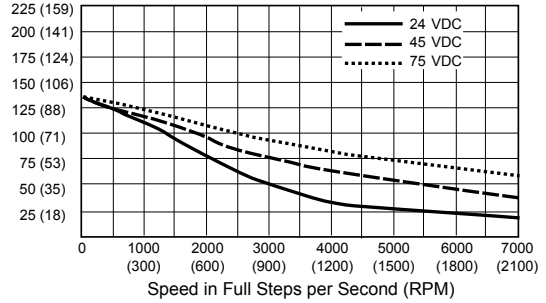

M-2231-6.0

Torque in Oz - In (N-cm)

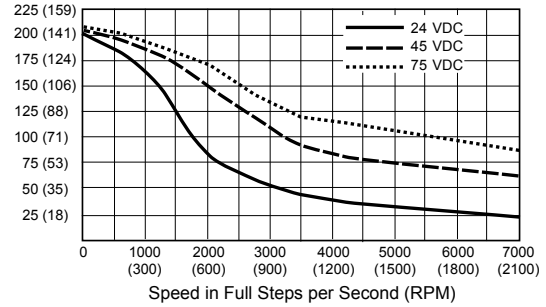

Optical Encoder Option

Dimensions in inches (mm)

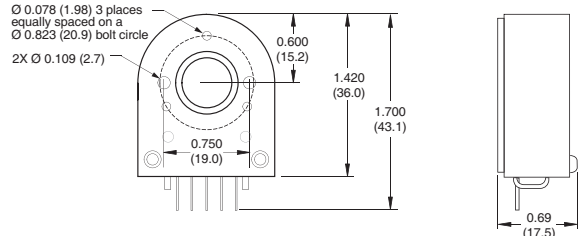

Connectivity single-end encoder

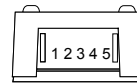

wire	function
1 Brown	Ground
2 Violet	Index
3 Blue	Channel A
4 Orange	+5 VDC input
5 Yellow	Channel B

optional interface cable available: ES-CABLE-2

differential encoder

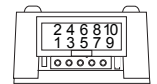

pin	function	pin	function
1	no connect	6	Channel A+
2	+5 VDC input	7	Channel B-
3	Ground	8	Channel B+
4	no connect	9	Index -
5	Channel A-	10	Index +

interface cable included

Timing

single-end encoder

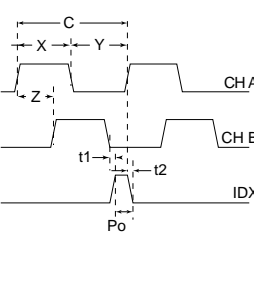

differential encoder

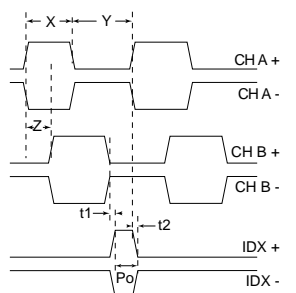

Parameter	Symbol	Min	Typ	Max	Units
Cycle error			3	5.5	°e
Symmetry		130	180	230	°e
Quadrature		40	90	140	°e
Index pulse width	Po	60	90	120	°e
Index rise (after Ch A or B rise)	t1	-300	100	250	ns
Index fall (after Ch A or B fall)	t2	70	150	1000	ns

C One cycle: 360 electrical degrees (°e).

X/Y Symmetry: the measure of the relationship between X and Y, nominally 180°e.

Z Quadrature: the phase lead or lag between channels A and B, nominally 90°e.

Po Index pulse width, nominally 90 °e.

NOTE: Rotation is as viewed from the cover side of the encoder.